



# OD-2025HD /OD-2025PHD

2-MegaPixel Outdoor 30fps 25  
meter IR IPCAM / Passive PoE  
2-MegaPixel Outdoor 30fps 25  
meter IR IPCAM

## User's Manual





## Owner's Record

The model and serial numbers are located at the bottom of device. Record these numbers in the spaces provided below. Refer to these numbers whenever you call upon your dealer regarding this product.

Model No. \_\_\_\_\_

Serial No. \_\_\_\_\_

### **WARNING**

**To prevent fire or shock hazard, do not expose the unit to rain or moisture.  
For AC Adaptor to avoid electrical shock, do not open the cabinet. Refer servicing to qualified personnel only.**



**Notice: The changes or modifications not expressly approved by the party responsible for compliance could void the user's authority to operate the equipment.**

## **For customers in the U.S.A.**

This equipment has been tested and found to comply with the limits for a digital device, pursuant to Part 15 of the FCC Rules. These limits are designed to provide reasonable protection against harmful interference in a residential installation. This equipment generates, uses, and can radiate radio frequency energy and, if not installed and used in accordance with the instructions, may cause harmful interference to radio communications. However, there is no guarantee that interference will not occur in a particular installation. If this equipment does cause harmful interference to radio or television reception, which can be determined by turning the equipment off and on, the user is encouraged to try to correct the interference by one or more of the following measures:

- Reorient or relocate the receiving antenna.
- Increase the separation between the equipment and receiver.
- Connect the equipment into an outlet on a circuit different from that to which the receiver is connected.
- Consult the dealer or an experienced radio/TV technician for help.

You are cautioned that any changes or modifications not expressly approved in this manual could void your authority to operate this equipment.

The shielded interface cable recommended in this manual must be used with this equipment in order to comply with the limits for a digital device pursuant to Subpart B of Part 15 of FCC Rules.

## **Declaration of Conformity**

This device complies with part 15 of the FCC Rules. Operation is subject to the following two conditions:

- (1) This device may not cause harmful interference, and
- (2) This device must accept any interference received, including interference that may cause undesired operation.



IMPORTANT NOTE: To comply with the FCC RF exposure compliance requirements, no change to the antenna or the device is permitted. Any change to the antenna or the device could result in the device exceeding the RF exposure requirements and void user's authority to operate the device.

## **NOTICE TO USERS**

© 2006~11 All rights reserved. This manual or the software described herein, in whole or in part, may not be reproduced, translated or reduced to any machine readable form without prior written approval.

WE PROVIDES NO WARRANTY WITH REGARD TO THIS MANUAL, THE SOFTWARE OR OTHER INFORMATION CONTAINED HEREIN AND HEREBY EXPRESSLY DISCLAIMS ANY IMPLIED WARRANTIES OF MERCHANTABILITY OR FITNESS FOR ANY PARTICULAR PURPOSE WITH REGARD TO THIS MANUAL, THE SOFTWARE OR SUCH OTHER INFORMATION. IN NO EVENT SHALL WE BE LIABLE FOR ANY INCIDENTAL, CONSEQUENTIAL OR SPECIAL DAMAGES, WHETHER BASED ON TORT, CONTRACT, OR OTHERWISE, ARISING OUT OF OR IN CONNECTION WITH THIS MANUAL, THE SOFTWARE OR OTHER INFORMATION CONTAINED HEREIN OR THE USE THEREOF.

We reserve the right to make any modification to this manual or the information contained herein at any time without notice. The software described herein may also be governed by the terms of a separate user license agreement.



## Table of Contents

<b>1. Introduction</b> .....	<b>1</b>
1.1 Overview.....	1
1.2 Package Contents .....	3
1.3 Connections.....	4
1.4 Passive PoE Installation (For OD-2025PHD Only) .....	7
1.5 Mounting the Camera .....	8
<b>2. Preparation</b> .....	<b>9</b>
2.1 Search and Set up by IPWizard II.....	9
2.1.1 Search .....	9
2.1.2 View.....	11
2.1.3 LAN .....	12
2.2 UPnP of Windows® XP, Vista or 7 .....	15
2.3 Install the Device behind a NAT Router .....	16
2.4 Access the Device from the Internet Explorer for the First Time .....	17
2.5 Logging in as an User.....	18
2.6 Logging in as an Administrator .....	18
<b>3. Operating the Network Camera</b> .....	<b>19</b>
<b>4. Administrating the Device</b> .....	<b>25</b>
4.1 Network: Configure Network Settings.....	26
4.1.1 Network .....	26
4.1.2 HTTPS.....	27
4.1.3 DDNS Service .....	28
4.1.4 PPPoE .....	30
4.1.5 Streaming.....	32
4.1.6 UPnP .....	33
4.1.7 Bonjour .....	34
4.1.8 ONVIF.....	35
4.1.9 IP Filter .....	36
4.1.10 IP Notification .....	37
4.2 Camera: Adjust Camera Parameters .....	40
4.2.1 Picture .....	40
4.2.2 Privacy Mask .....	42
4.2.3 PTZ Setting.....	43
4.2.4 Preset Setting.....	44
4.2.5 Tour Setting .....	45



4.3 System: Configure and Maintain System.....	46
4.3.1 System .....	46
4.3.2 Date & Time.....	47
4.3.3 Maintenance .....	49
4.4 Video: Configure Profile .....	51
4.4.1 Common.....	51
4.4.2 Video Profile .....	52
4.4.3 ROI .....	53
4.5 Audio: Audio Parameters .....	54
4.6 User: Manage User Name, Password and Login Privilege .....	55
4.7 E-Mail: Setup E-Mail Configuration.....	56
4.8 Object Detection: Setup Object Detection .....	57
4.9 Event Server: Setup FTP/TCP/HTTP/SAMBA Server Configuration .....	58
4.11.1 FTP Server .....	58
4.11.2 TCP Server.....	60
4.11.3 HTTP Server.....	61
4.11.4 SAMBA Server .....	62
4.10 Event Schedule: Configure the Event Schedule .....	63
4.12.1 Setting .....	63
4.12.2 Record.....	68
<b>5. Appendix.....</b>	<b>69</b>
Appendix A: Alarm I/O Connector .....	69
Appendix B: Troubleshooting & Frequently Asked Questions.....	71
Appendix C: PING IP Address .....	76
Appendix D: Bandwidth Estimation.....	77
Appendix E: Specifications .....	78
Appendix F: Configure Port Forwarding Manually .....	80
Appendix G: DDNS Application .....	83
Appendix H: Power Line Frequency .....	89
Appendix I: 3GPP .....	91
Appendix J: Enable UPnP of Windows XP .....	92



# 1

## Introduction



### 1.1 Overview

This user's guide explains how to operate this camera from a computer. User should read this manual completely and carefully before you operate the device.

The AirLive OD-2025HD/OD-2025PHD are high-end 2.0 MegaPixel (MP) network camera which designs for professional outdoor surveillance and security applications. This 2.0MP IP camera offers much improvements in image quality when compares to conventional surveillance cameras. Users are able to view live video streaming over the Internet, and it is only one of benefits for using AirLive IP Camera.

It is also designed to offer high-performance surveillance and the AirLive OD-2025HD equipped with PoE port which allows power and data to be transmitted via a single Ethernet cable. This useful function provides an easier installation, lower cabling costs and allows placement of AirLive PoE cameras in locations without access to electrical source.



The AirLive OD-2025PHD supports 12V Passive POE which can not only has the advantage of the easier installation, lower cabling cost, but also provides low voltage consumption. This feature will greatly help installing the OD-2025PHD in the environment where power is an issue.

With the IP-66 waterproof housing, AirLive OD-2025HD/OD-2025PHD suits for environments such as stairs, main entrance, street, and basement.

The device is accessible via the LAN or Internet connection. Connect your device directly to a local area network or xDSL modem, and with Microsoft® Internet Explorer you get instant, on demand video streams. Within minutes you can set up the device to capture a video sequence to a PC. The live video can be uploaded to a website for the world to see.

**Note:** *AirLive OD-2025PHD uses 12V passive PoE. It is not compatible with 802.3af or 802.3at PoE switch. Please do not connect this IP camera to PoE switch, or the IP camera might be damaged.*

## Features

- 2.0 Mega CMOS H.264 IP Camera
- Up to 1920 x 1080@30fps
- Viewing the Video via 3/3.5G Mobile Phone
- Support 802.3af Power over Ethernet
- IP-66 Weatherproof Housing for most of Environments
- With High Illuminate IR LED, Project up to 25 Meters
- Support H.264, MPEG, MJPEG
- Compatible with ONVIF standard
- Support Two-Way Audio
- Support Samba Server
- Support Cam Pro Express 64 Channels

## Minimum System Requirements

- Microsoft Internet Explorer 6.0 or later
- Microsoft Media Player 11.0 or later (to playback recorded file)
- VGA Monitor resolution 1280 x 1024 or higher
- Pentium-4 3.6 GHz or higher
- Memory Size: 1GB or more
- Windows XP, Vista, 7



## 1.2 Package Contents

User can find the following items in the package:

Item	Descriptions
	<p><b>1. OD-2025HD or OD-2025PHD</b> is the main element of the product.</p>
	<p><b>2. Wall mount</b></p>
	<p><b>3. Wall mount stand</b></p>
	<p><b>2. Screws x 3</b></p>
	<p><b>3. Power Adapter</b> dedicates 12V DC electric power output to Network Camera.</p>
 <p data-bbox="536 1989 659 2004">Size: 78 x 78 mm</p>	<p><b>4. User's Manual CD</b> provides installation software, application program, important information and instructions for operating the Network Camera.</p>



	<p><b>5. Quick Start Guide</b> provides important information and instructions for installing this device.</p>
	<p><b>6. PoE 1P:</b> passive PoE injector (OD-2025HD only).</p>

**Note:** Using a power supply with a different voltage than the one included with the Network Camera will cause damage and void the warranty for this product.

### 1.3 Connections

#### OD-2025HD





## OD-2025PHD

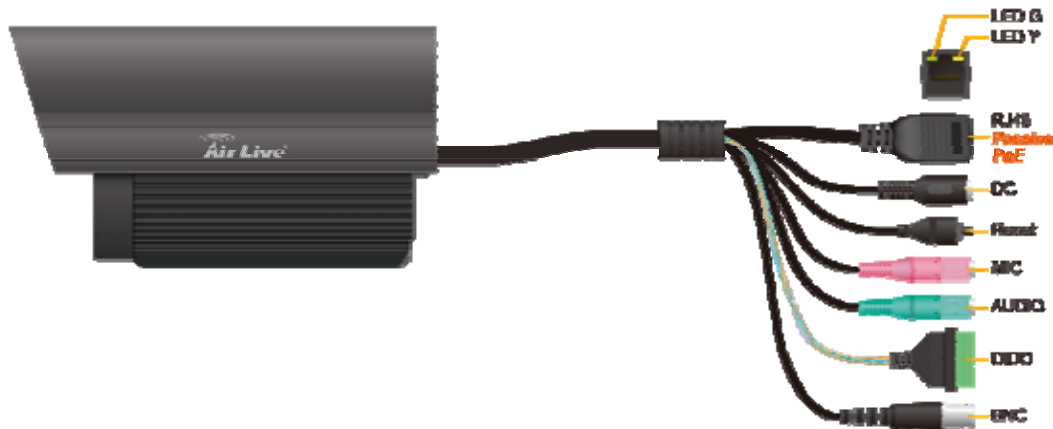

### 1. RJ45 LAN socket: Connect to PC or Hub/Switch.

For connections to 10Base-T Ethernet or 100Base-TX Fast Ethernet cabling. This Ethernet port built N-Way protocol can detect or negotiate the transmission speed of the network automatically. Please use Category 5 cable to connect the Network Camera to a 100Mbps Fast Ethernet network switch or hub.

In the LAN socket, there are two LEDs embedded:

#### LAN LED (green color)

This LED will be flashing while network accessing via Ethernet.

#### Power (orange color)

This LED is used to indicate whether DC power is on or not. In addition, this LED will be flashing while the wireless accessing of the Camera.

### 2. DI/DO connector:

DI/ DO: Connect to sensor in and alarm out devices

Cable for I/O connectors:

Name	Cable Color	Function
12VDC	Brown/White	DC 12V (50mA maximum)
GND	Blue/White	GND
NC	Purple/White	Do not connect
NC	Gray	Do not connect
DI	Green/White	Digital signal input



DO	Orange/White	Digital signal output
----	--------------	-----------------------

### 3. Factory Default Reset

This button is used to restore the all factory default settings. Sometimes restarting the device will make the system back to a normal state. However, if the system still got problems after restart, user can restore the factory default settings and install it again.

#### Restore the device:

- (i) Press the button down continuously.
- (ii) Hold the button at least 5s seconds and release it. Then the device has been restored to default settings and reboot again.

**Note:** Restoring the factory default setting will lose the all previous settings included IP address forever. User needs to run the IPWizard II program to search the device and configure it to let the device work properly again.

### 4. DC-in Jack

The input power is 12VDC. **Note** that supply the power to the Network Camera with the power adapter included in package.

### 5. MIC in (audio in)

Connect a microphone to the network camera.

### 6. Line out (audio out)

Connect a loud speaker to the network camera. This function is for voice alerting and two-way audio.

### 7. BNC Connector

The composite video format will be sent out through this connector. User might connect the IP Camera to a monitor or DVR via this connector.



## 1.4 Passive PoE Installation (For OD-2025PHD Only)

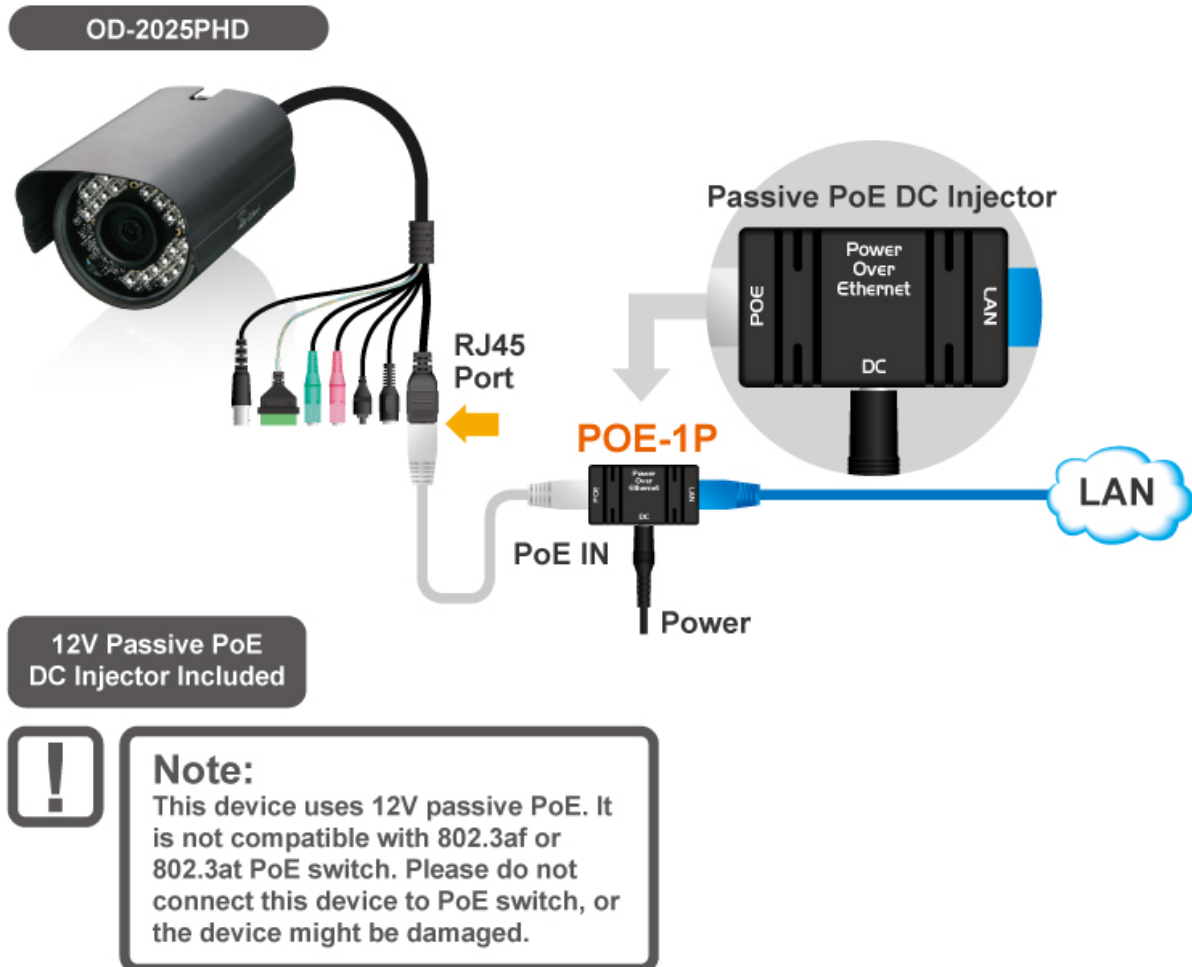

1. Connect the cable from the switch to the LAN port on the POE-1P
2. Connect the cable from the IP camera to the POE port, please note, for delivering the power properly, this should be a 4 twisted pair cable.
3. Plug the 12DC adapter to the DC phone jack.



## 1.5 Mounting the Camera

### Ceiling Mount

Fix the camera with bundle wall mount kit as below.



### Install the Camera in LAN

1. Plug an Ethernet cable into the Camera

Connect an Ethernet cable to the LAN socket and attach it into the network.

2. Connect the external power supply to Camera

Connect the attached power adapter to the DC power jack of the camera. **Note:** Use the power adapter, 12VDC, included in the package and connect it to wall outlet for AC power.

Once you have installed the camera well and powered it on, the power LED (orange) will turn on later. The power LED turned on, it means the system is booting up successfully. Furthermore, if you have a proper network connection, and access to the camera, the LAN LED (green) will flash.

# 2

## Preparation

### 2.1 Search and Set up by IPWizard II

When you installed the Camera on a LAN environment, you have two easy ways to search your Cameras by IPWizard II or UPnP™ discovery. Here is the way to execute IPWizard II to discover Camera's IP address and set up related parameter in a Camera.

#### 2.1.1 Search

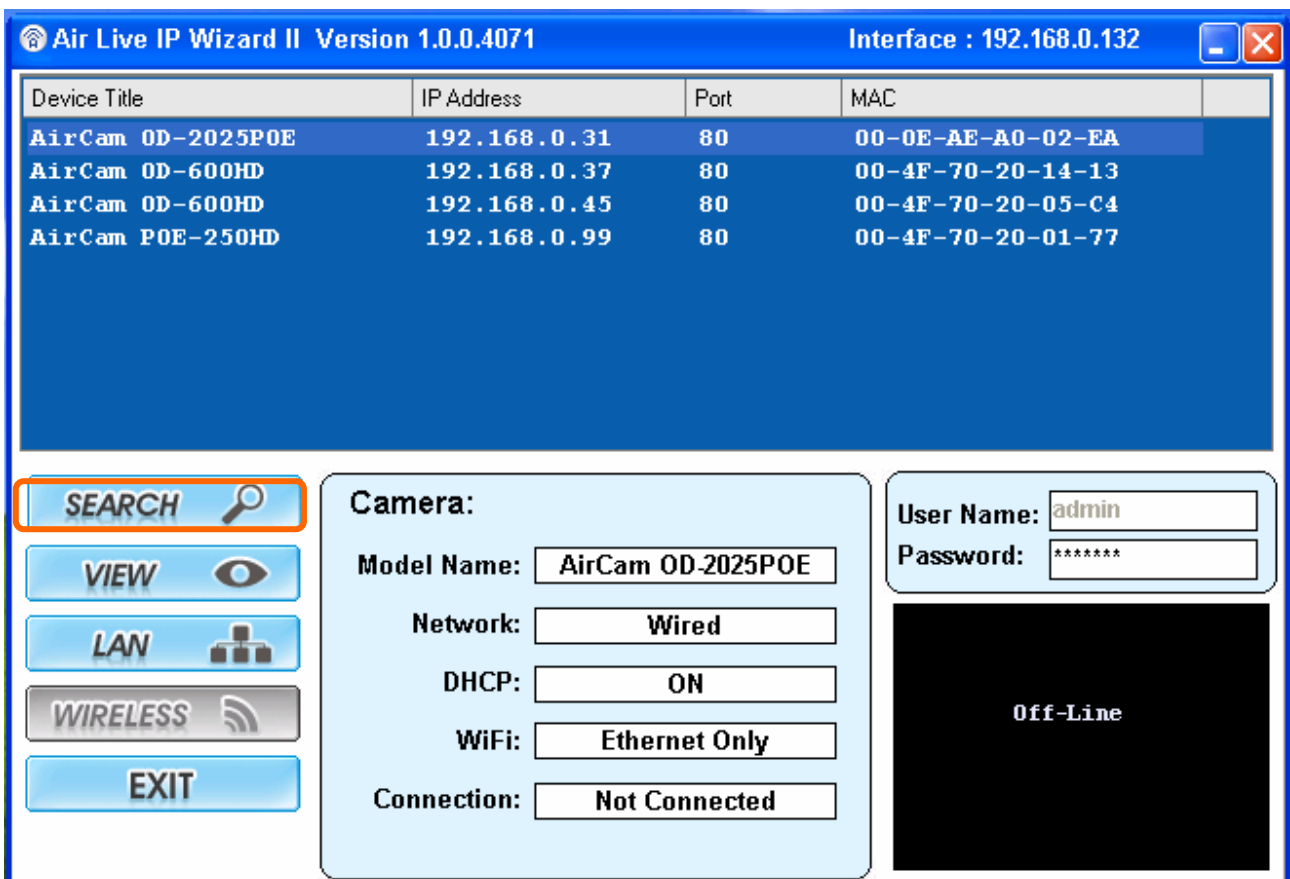



**Air Live IP Wizard II Version 1.0.0.4071** Interface : 192.168.0.132

Device Title	IP Address	Port	MAC
AirCam OD-2025POE	192.168.0.31	80	00-0E-AE-A0-02-EA
AirCam OD-600HD	192.168.0.37	80	00-4F-70-20-14-13
AirCam OD-600HD	192.168.0.45	80	00-4F-70-20-05-C4
AirCam POE-250HD	192.168.0.99	80	00-4F-70-20-01-77

**SEARCH** 

**VIEW** 

**LAN** 

**WIRELESS** 

**EXIT**

**Camera:**

**Model Name:**

**Network:**

**DHCP:**

**WiFi:**

**Connection:**

**User Name:**

**Password:**

Off-Line



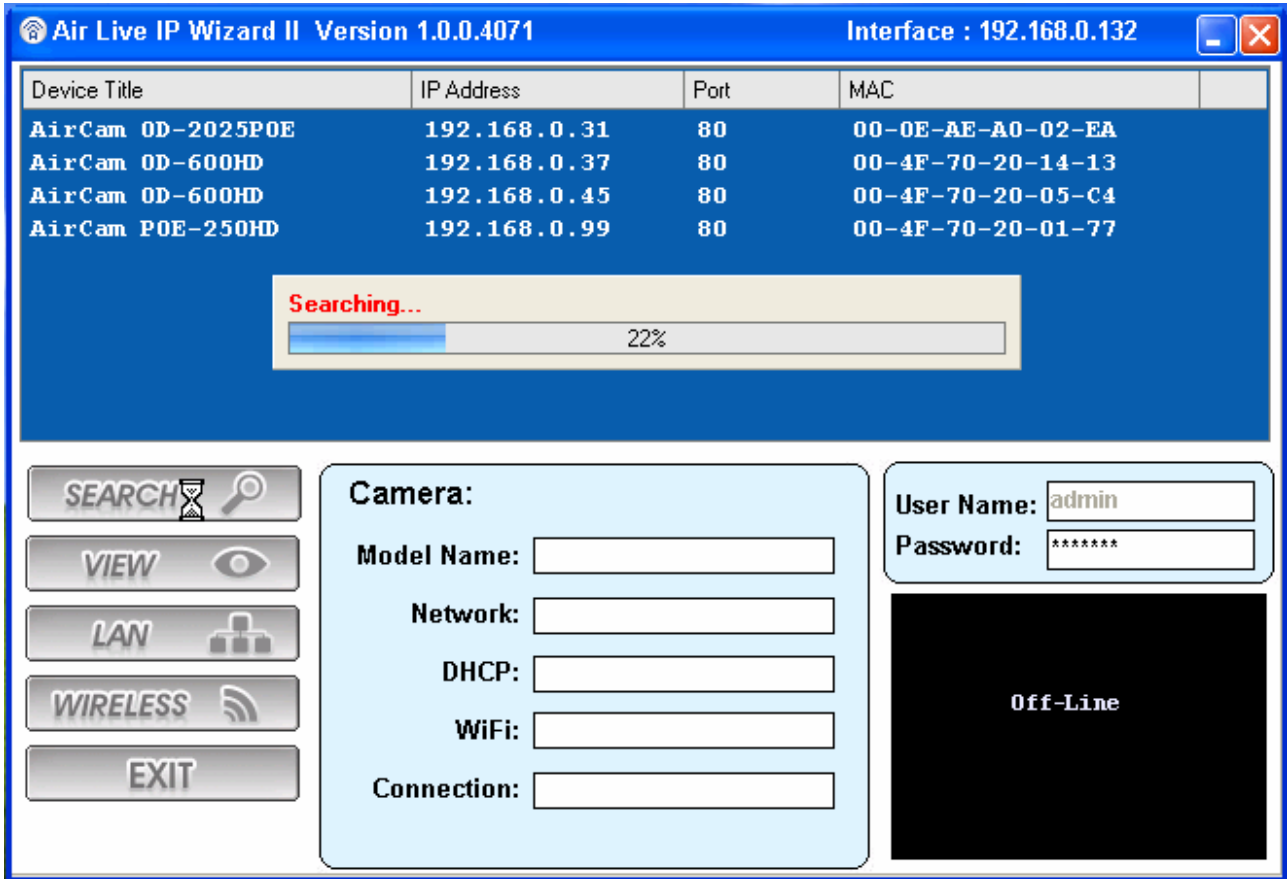

When launch the IPWizard II, a searching window will pop up. IPWizard II is starting to search Network Cameras on the LAN. The existed devices will be listed as below.



**Air Live IP Wizard II Version 1.0.0.4071** Interface : 192.168.0.132

Device Title	IP Address	Port	MAC
AirCam OD-2025POE	192.168.0.31	80	00-0E-AE-A0-02-EA
AirCam OD-600HD	192.168.0.37	80	00-4F-70-20-14-13
AirCam OD-600HD	192.168.0.45	80	00-4F-70-20-05-C4
AirCam POE-250HD	192.168.0.99	80	00-4F-70-20-01-77

Searching... 22%

**SEARCH**   
**VIEW**   
**LAN**   
**WIRELESS**   
**EXIT**

**Camera:**  
**Model Name:**   
**Network:**   
**DHCP:**   
**WiFi:**   
**Connection:**

**User Name:**   
**Password:**

**Off-Line**

## 2.1.2 View

If IPWizard II finds network devices, **View** button will be available. Please select the device you want to view and click the **View** button. Then you could see the video from camera directly. Furthermore you could double click the left button of mouse to link to the network device by browser.

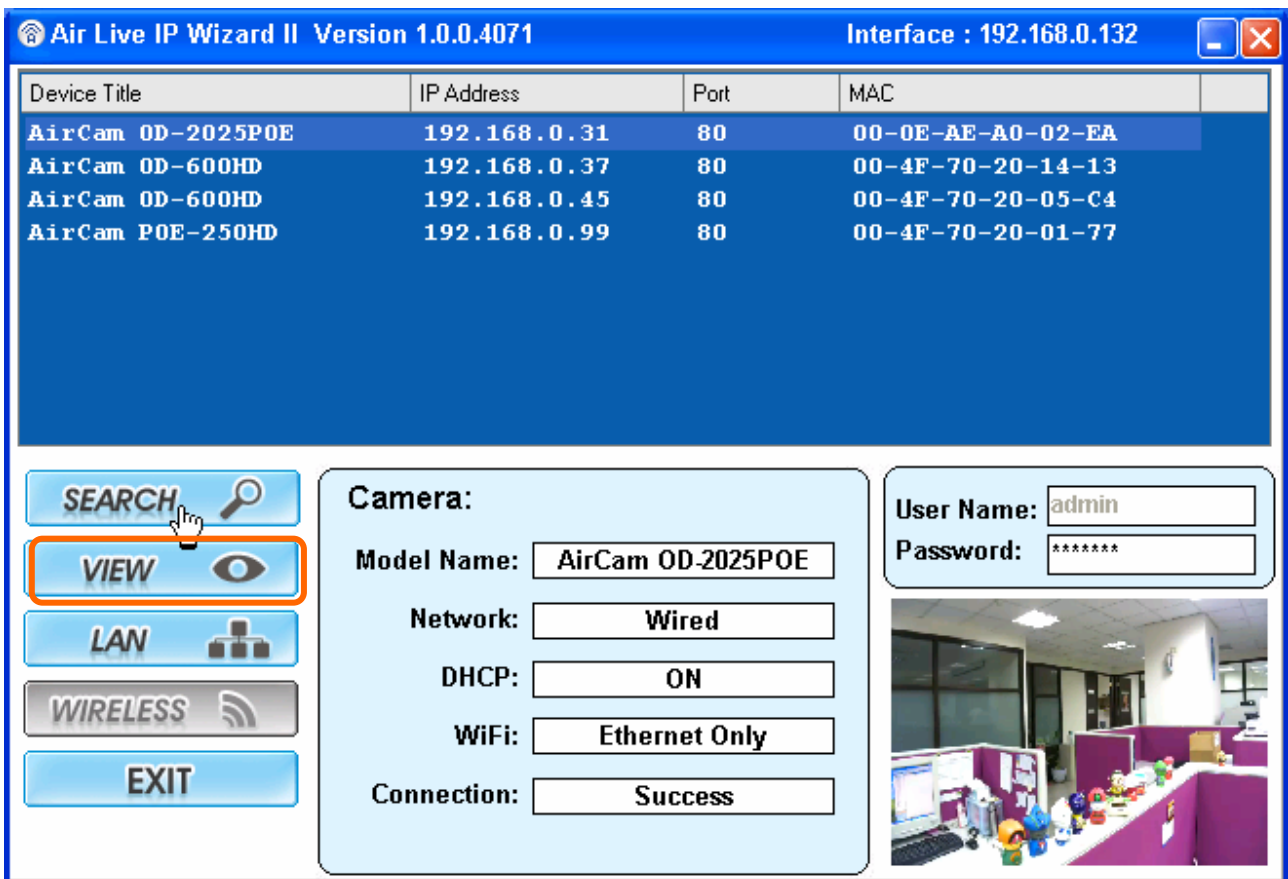

The screenshot shows the 'Air Live IP Wizard II Version 1.0.0.4071' interface. The title bar indicates the interface IP is 192.168.0.132. A table lists discovered devices:

Device Title	IP Address	Port	MAC
AirCam OD-2025POE	192.168.0.31	80	00-0E-AE-A0-02-EA
AirCam OD-600HD	192.168.0.37	80	00-4F-70-20-14-13
AirCam OD-600HD	192.168.0.45	80	00-4F-70-20-05-C4
AirCam POE-250HD	192.168.0.99	80	00-4F-70-20-01-77

Below the table are navigation buttons: SEARCH, VIEW (highlighted with an orange border), LAN, WIRELESS, and EXIT. A 'Camera:' configuration panel shows the following settings:

- Model Name: AirCam OD-2025POE
- Network: Wired
- DHCP: ON
- WiFi: Ethernet Only
- Connection: Success

On the right, there are input fields for 'User Name: admin' and 'Password: \*\*\*\*\*', and a small video preview window showing an office scene.

### 2.1.3 LAN

In case you want to change the IP related parameters of wired interface, please select the device you want to configure and click the **LAN** button. Relative settings will be carried out as below.

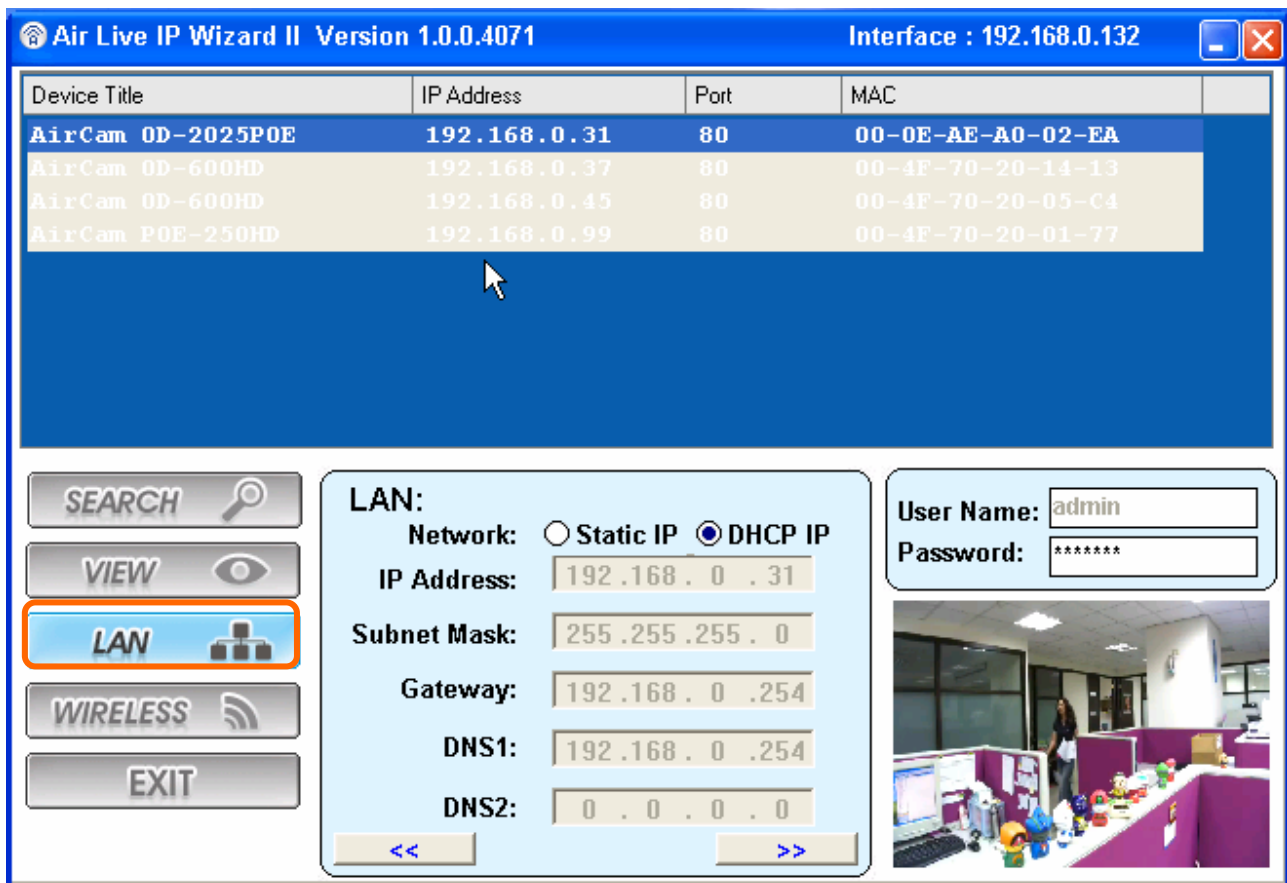

The screenshot shows the 'Air Live IP Wizard II Version 1.0.0.4071' window. The title bar indicates the current interface IP is 192.168.0.132. A table lists four devices with their respective IP addresses, ports, and MAC addresses. Below the table, there are navigation buttons: SEARCH, VIEW, LAN (highlighted with an orange border), WIRELESS, and EXIT. The LAN configuration panel is active, showing options for Network (Static IP or DHCP IP), IP Address (192.168.0.31), Subnet Mask (255.255.255.0), Gateway (192.168.0.254), DNS1 (192.168.0.254), and DNS2 (0.0.0.0). To the right, there are fields for User Name (admin) and Password (\*\*\*\*\*). A small inset image shows a person in an office environment.

Device Title	IP Address	Port	MAC
AirCam OD-2025POE	192.168.0.31	80	00-0E-AE-A0-02-EA
AirCam OD-600HD	192.168.0.37	80	00-4F-70-20-14-13
AirCam OD-600HD	192.168.0.45	80	00-4F-70-20-05-C4
AirCam POE-250HD	192.168.0.99	80	00-4F-70-20-01-77

You could modify the relative settings of the selected device. Click “<<” button will quit the LAN setting procedure and click “>>” button will move to next page as below.

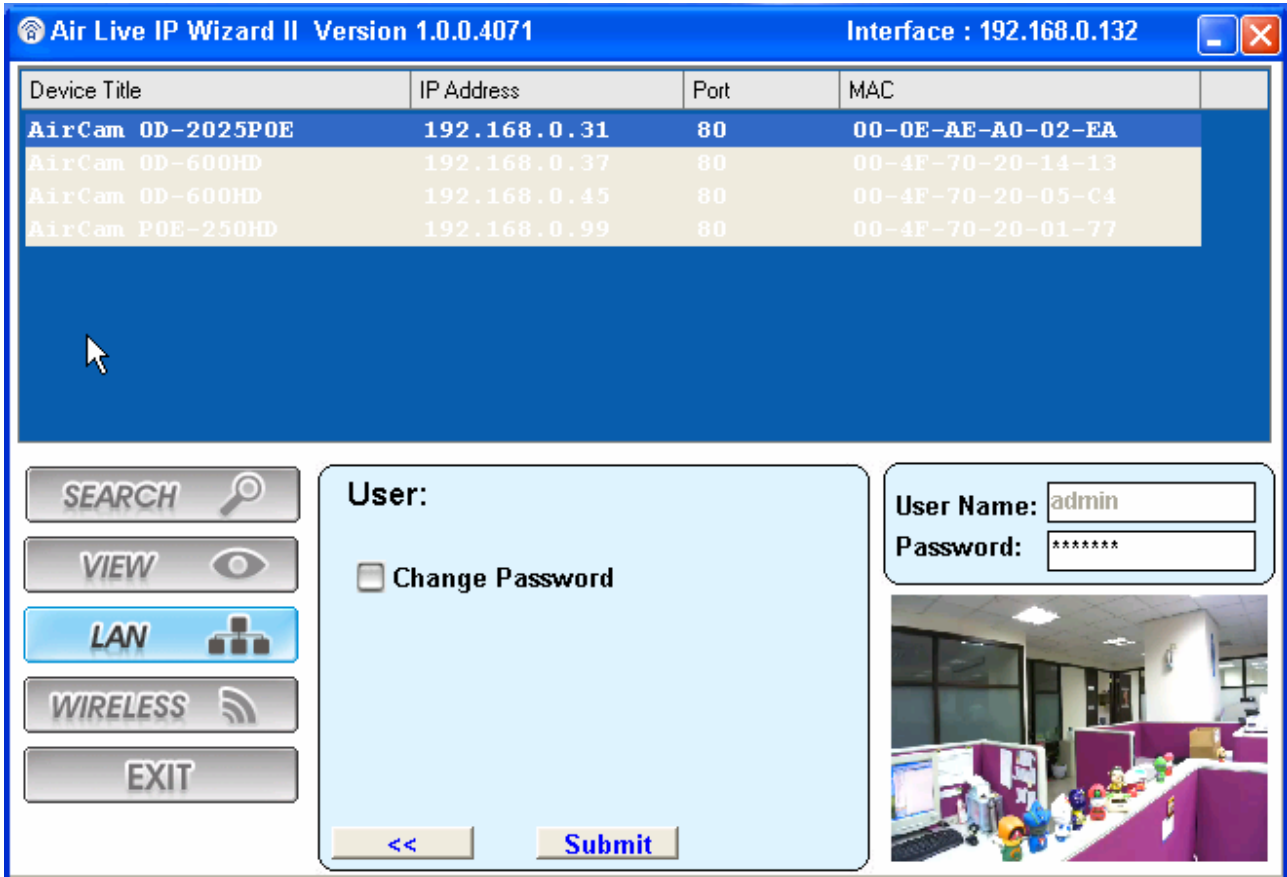

Device Title	IP Address	Port	MAC
AirCam OD-2025POE	192.168.0.31	80	00-0E-AE-A0-02-EA
AirCam OD-600HD	192.168.0.37	80	00-4F-70-20-14-13
AirCam OD-600HD	192.168.0.45	80	00-4F-70-20-05-C4
AirCam POE-250HD	192.168.0.99	80	00-4F-70-20-01-77

SEARCH

VIEW

**LAN**

WIRELESS

EXIT

User:

Change Password

<<

Submit

User Name: admin

Password: \*\*\*\*\*



In case, you do not want to change username and/or password, then just click “**Submit**” button to perform your setting accordingly. Click “<<” button will go back to previous page. If you like to change username and/or password of the device, just click the check button. Then, the related fields will show up as below.

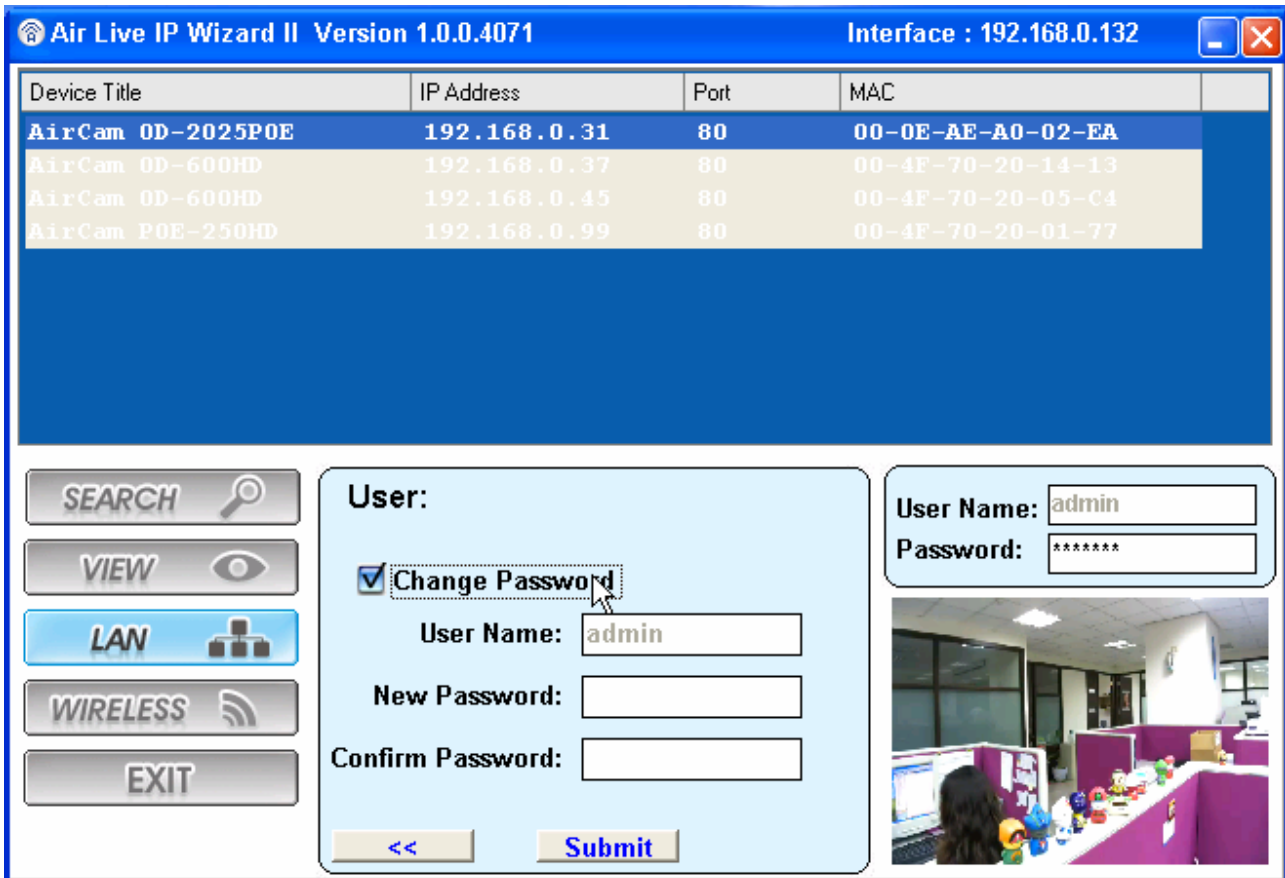

The screenshot shows the 'Air Live IP Wizard II Version 1.0.0.4071' interface. The top bar indicates the interface IP is 192.168.0.132. Below the title bar is a table with the following data:

Device Title	IP Address	Port	MAC
AirCam OD-2025POE	192.168.0.31	80	00-0E-AE-A0-02-EA
AirCam OD-600HD	192.168.0.37	80	00-4F-70-20-14-13
AirCam OD-600HD	192.168.0.45	80	00-4F-70-20-05-C4
AirCam POE-250HD	192.168.0.99	80	00-4F-70-20-01-77

Below the table are navigation buttons: SEARCH, VIEW, LAN (highlighted), WIRELESS, and EXIT. To the right is a 'User:' configuration panel with the following fields and options:

- Change Password
- User Name: admin
- New Password: [empty]
- Confirm Password: [empty]
- Buttons: << and Submit

On the far right, there is a 'User Name:' field with 'admin' and a 'Password:' field with '\*\*\*\*\*'. Below these is a small image of a person at a computer workstation.

After keying in new username and password, click “**Submit**” button to perform your setting accordingly. Click “<<” button will go back to previous page.

## 2.2 UPnP of Windows® XP, Vista or 7

UPnP™ is short for Universal Plug and Play, which is a networking architecture that provides compatibility among networking equipment, software, and peripherals. This device is an UPnP enabled device. If the operating system, Windows XP, Vista or 7, of your PC is UPnP enabled, the Network Camera will be very easy to be found.

Please refer to Appendix J to enable UPnP settings only if your operating system of PC is running Windows XP.

**Note:** Windows 2000 does not support UPnP feature.

To discover your device, go to your Desktop and click **My Network Places**.

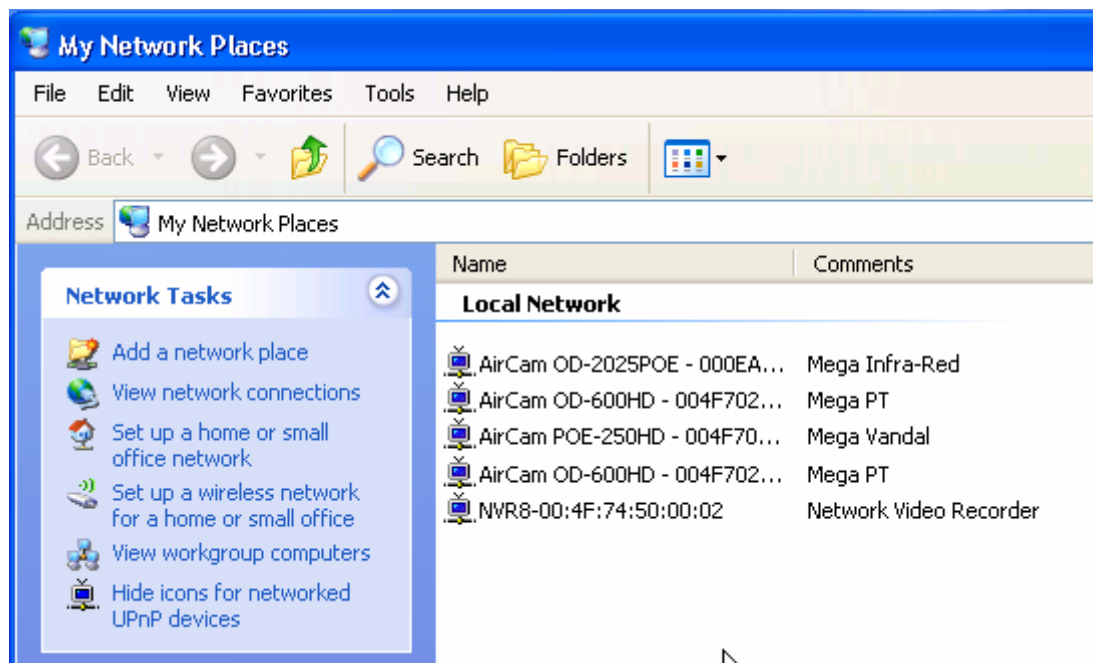

Click the targeted **Device**. Then Internet Explorer will connect to this Network Camera automatically.

## 2.3 Install the Device behind a NAT Router

Once installed, the device is accessible on your LAN. To access the device from the Internet you must configure your broadband router to allow incoming data traffic to the device. If the device is installed on the LAN with a router, then it may get a dynamic IP address from the DHCP server. However, if the device wants to be accessed from the WAN, its IP address needs to be setup as fixed IP, also the port forwarding or Virtual Server function of router needs to be setup.

However, if your NAT router supports UPnP feature, it can be very easy to achieve NAT traversal automatically. To do this, enable the NAT-traversal feature, which will attempt to automatically configure the router to allow access to the camera.

Installing the device with an UPnP router on your network is an easy 3–step procedure:

- (1) Enable UPnP option of your NAT router
- (2) Enable UPnP NAT traversal option of the Network Camera (default)
- (3) Access your Network Camera by DIPS

### (1) Enable UPnP option of your NAT router

To use UPnP IGD function (NAT traversal), you need to make sure the UPnP function is enabled in your router. Most new home routers should support this function. Some of routers are default enable and others are not. Please check user's manual of your NAT router for detail.

### (2) Enable UPnP NAT traversal option of the Network Camera

Refer to **Setting → Network → UPnP** page for detail NAT traversal setting. Note that this option is default enabled.

### (3) Access your Network Camera by DIPS

Refer to **Setting → System → System** page for detail DIPS information.

## 2.4 Access the Device from the Internet Explorer for the First Time

1. Start the web browser on the computer and type the IP address of the Camera you want to monitor as below:



The Login Window of the Camera is prompted:



2. Type in your login name and password under “USERNAME” and “PASSWORD” textbox.

For the first time use (default value), input the

User Name: **admin**

Password: **airlive**

That's, type in “**admin**” on the “USERNAME” and “**airlive**” on the “PASSWORD”. Click “OK” button to start the main menu.

3. According your browser's security setting, the IE Web Page may prompt the “Security Warning” window. If so, select “Yes” to install and run the ActiveX control into your PC. Otherwise, the system will load the ActiveX silently.

4. After the ActiveX control was installed and ran, the first image will be displayed.

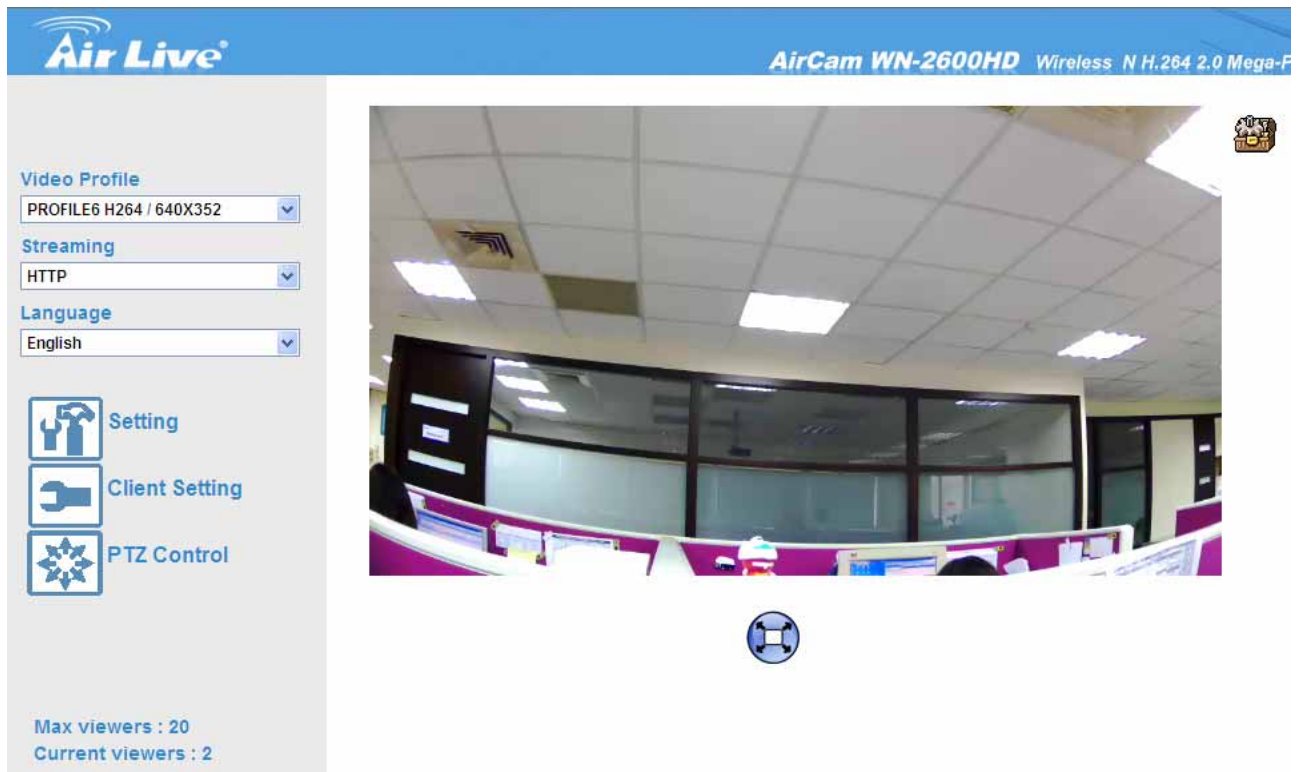

## 2.5 Logging in as an User

If you log in the Camera as an ordinary User, “Setting” function will be not accessible.

## 2.6 Logging in as an Administrator

If you log in the Camera as the Administrator, you can perform all the settings provided by the device.

# 3

## Operating the Network Camera

Start-up screen will be as follow no matter an ordinary users or an administrator.



### Monitor Image Section

The image shot by the device is shown here. The date and time are displayed at the top of the window.

### Video Profile

The device supports multi-profile function for H.264, MPEG4 and JPEG simultaneously. User can chose the proper and/or preferred profile which is listed here.

### Streaming Protocol

User can select proper streaming protocol according to networking environment.

### Language

The device could provide multiple languages to meet customer's requirement.

## 2-Way Audio

The device supports 2-way audio function. User can chose to enable or disable this function by toggling the icon below.



: Disable audio uploading function.



: Enable audio uploading function.

## Full Screen

Enlarge video to full screen display.



: Enlarge video to full screen display. Press “ESC” key to disable this function.

## PTZ Control

Click to display the following control panel:

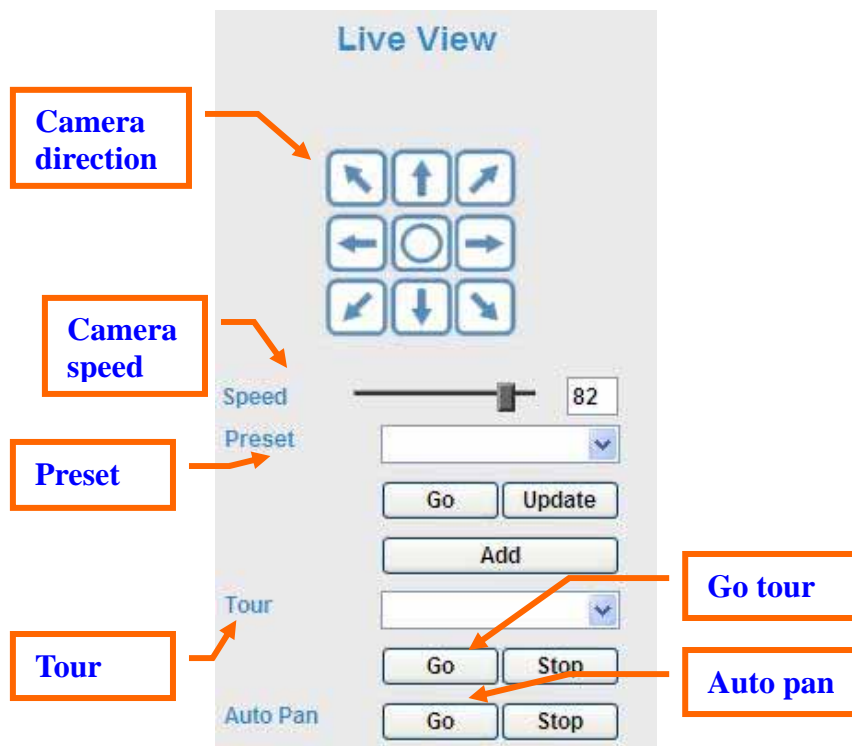

- Camera direction:  
Control camera up/down/left/right and home position.

- **Camera speed:**  
Choose the speed of Pan and Tilt.
- **Preset:**  
Add/Update the preset positions or go to one of these positions.
- **Tour:**  
Select one of the camera tours. Camera tour is comprised by series of preset locations.
- **Go tour:**  
Execute the selected camera tour.
- **Auto Pan:**  
Execute the auto pan of camera. While auto pan is running, the camera will swing the camera automatically. Note that the speed of auto pan is fixed and can not be adjustable.

## **ActiveX Control**

The plug-in ActiveX control supports a lot of functions by clicking the left mouse button. Note that this feature only supports on the ActiveX control within Microsoft® Internet Explorer.

On the ActiveX control icon, click the LeftMouseButton, then a menu pop-up. This menu provides features that are unique to the ActiveX control. These features include:

- "Digital Zoom",
- "Snapshot",
- "Record",
- "Volume",
- "About"

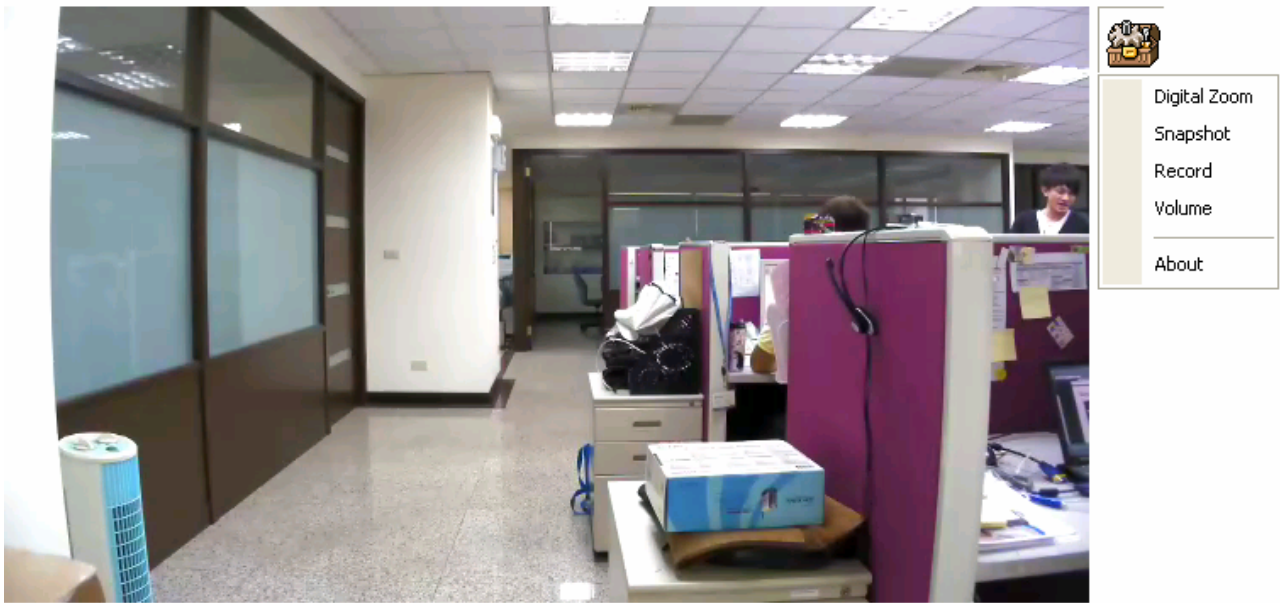

- Digital Zoom

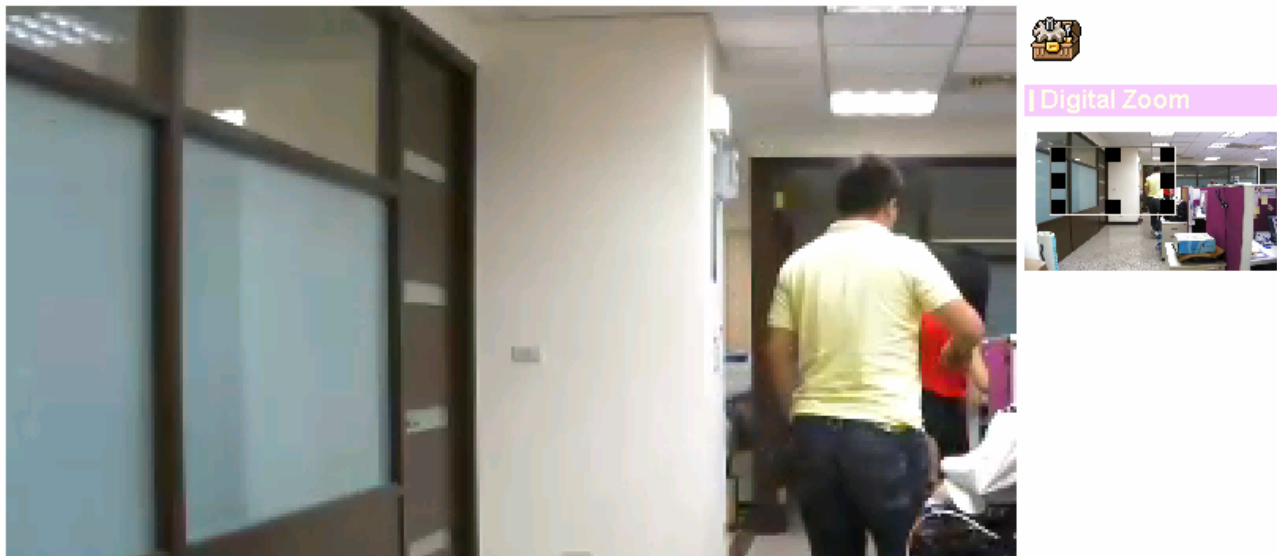

Click **Digital Zoom** to activate this function as above. User can drag or scale the box over the video to adjust zoom ratio and position.

- Snapshot



Click Snapshot to activate this function. Press Snapshot button to take a picture. The image file is saved as JPEG format into your local PC. Select Browser, the pop-up window to select the save path and file name prefix, select OK to continue.

If you like to retrieve the saved image, select the file to display the saved image by using any one of graph editing tools.

- Record

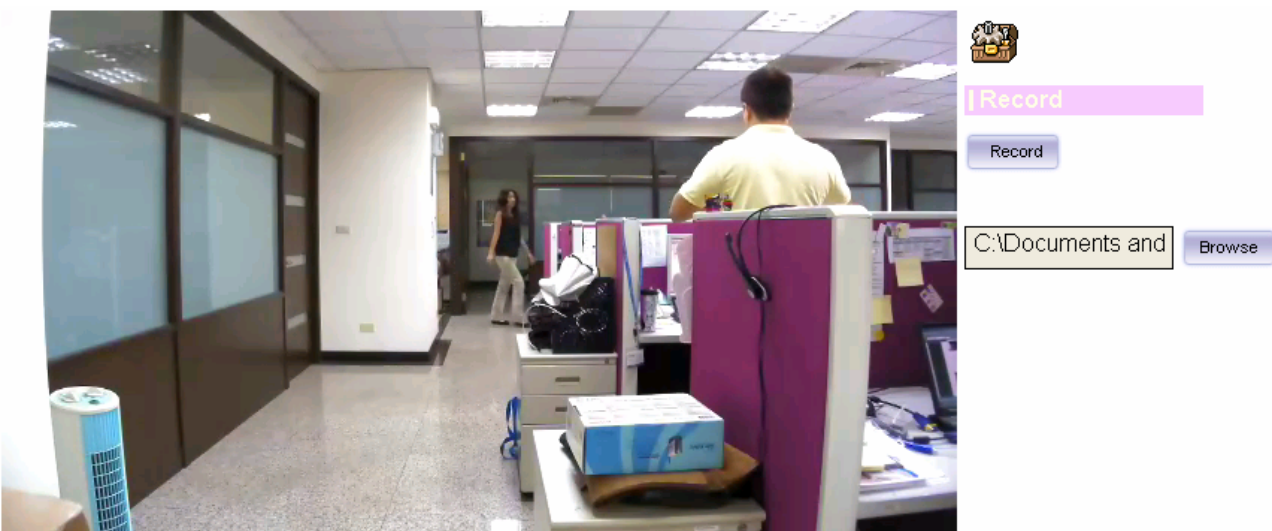

Click Record to activate this function. Press Record button to start recording. The video file is saved as ASF format into your local PC. While you want to stop it, press Stop to stop recording. Select Browser, the pop-up window to select the save path and file name prefix, select OK to continue.

After stop recording, list the files, this file is named as Video\_yyyymmddhhmmss.avi  
The ASF files can be display by the standard Windows Media Player, but it needs the  
DirectX 9.0 or later version to be installed.

- Volume

Click Volume to activate this function. There are two control bars for speaker and  
microphone volume respectively. Scroll these control bars to adjust the audio attribute.  
Check the volume mute will mute the speaker output.



- About

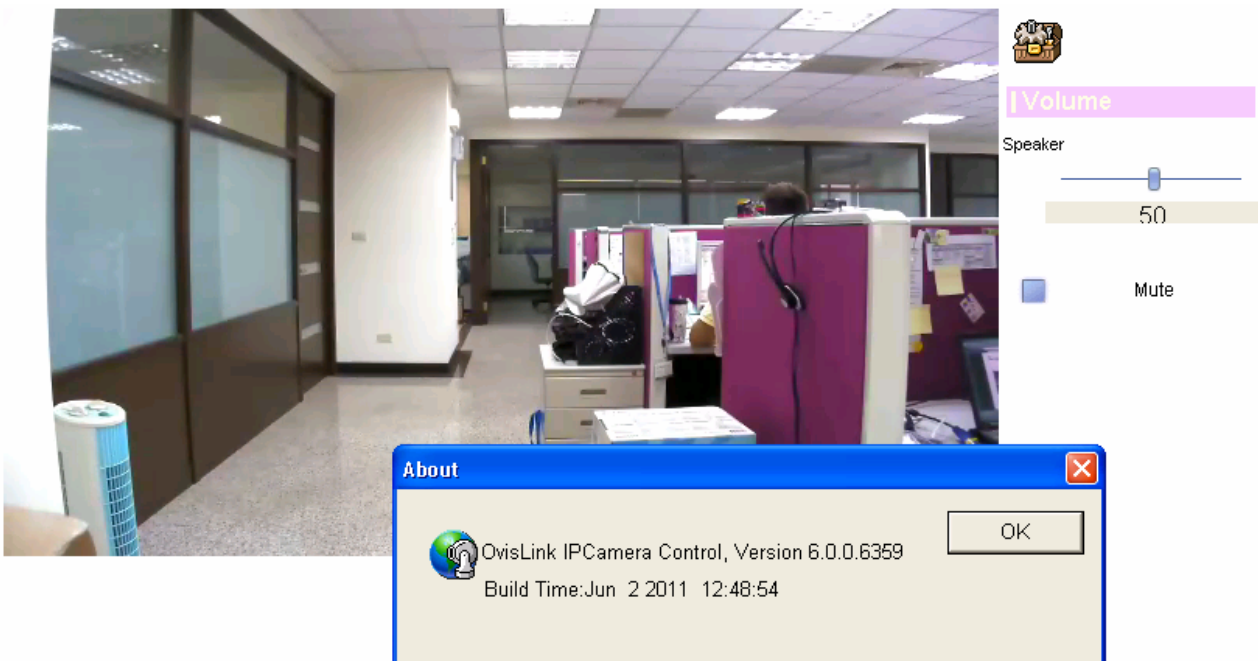

Click About to show this ActiveX information.

# 4

## Administrating the Device

### System Setting

This function is only available for user logged into Camera as administrator.

Click on each menu name to display its setting page.

Item	Action
Network	Configure Network settings such as DHCP, DDNS, 3GPP, PPPoE and UPnP
Camera	Adjust camera parameters, position, and set camera tour
System	Configure system information, date & time, maintenance, and view system log file.
Video	Configure bit rate and frame rate of video profiles
Audio	Configure audio parameters
User	Setup user name, password and login privilege
E-Mail	Setup E-Mail configuration
Object Detection	Setup Object detection
Storage	Status and configuration of SD card
Recording List	Files list inside the SD Card
Event Server	Setup FTP/TCP/HTTP server for event
Event Schedule	Configure the schedule while event triggered

## 4.1 Network: Configure Network Settings

Use this menu to configure the network to connect the device and the clients.

### 4.1.1 Network

This section provides the menu for connecting the device through Ethernet cable.

Network
HTTPS
DDNS
PPPoE
Streaming
UPnP
Bonjour
ONVIF
IP Filter
IP Notification

MAC Address 00:4F:62:00:01:02

Obtain IP address automatically (DHCP)

IP Address  Test

Subnet Mask

Gateway

Obtain DNS from DHCP

Primary DNS

Secondary DNS

HTTP Port  (1 ~ 65535) Test

OK
Cancel

- **MAC address:**  
Displays the Ethernet MAC address of the device. Note that user can not change it.
- **Obtain IP address automatically (DHCP):**  
DHCP: Stands for Dynamic Host Configuration Protocol.

Enable this checked box when a DHCP server is installed on the network to issue IP address assignment. With this setting, the IP address is assigned automatically. If this device can not get an IP address within limited tries, the device will assign a default IP address, 192.168.0.100, by itself as the default IP address.

- IP address, Subnet mask, and Gateway:

If you do not select Obtain an IP address automatically, then you need to enter these network parameters manually.

- Obtain DNS from DHCP:  
DNS: Stands for Domain Name System.

Enable this checked box when a DHCP server is installed on the network and provide DNS service.

- Primary DNS and Secondary DNS:  
If you do not select Obtain DNS from DHCP, then you need to enter these parameters manually.

- HTTP Port:

The device supports two HTTP ports. The first one is default port 80 and this port is fixed. This port is very useful for Intranet usage. The second HTTP port is changeable. Users could assign the second port number of http protocol, and the WAN users should follow the port number to login. If the http port is not assigned as 80, users have to add the port number in back of IP address. For example:

`http://192.168.0.100:8080`.

Therefore, the user can access the device by either

`http://xx.xx.xx.xx/`, or

`http://xx.xx.xx.xx:xxxx/` to access the device.

If multiple devices are installed on the LAN and also required to be accessed from the WAN, then the HTTP Port can be assigned as the virtual server port mapping to support multiple devices.

Click “OK” to save and enable the setting.

#### 4.1.2 HTTPS

User can enable HTTPS for securing the video data if he enabled the HTTPS function.

Network	<b>HTTPS</b>	DDNS	PPPoE	Streaming	UPnP	Bonjour	ONVIF	IP Filter	IP Notification
---------	--------------	------	-------	-----------	------	---------	-------	-----------	-----------------

HTTPS  Disable  Enable

HTTP & HTTPS  HTTPS only

Port  (1 ~ 65535)

- **HTTPS Enable/Disable**  
Use this function to enable or disable the HTTPS function.
  
- **HTTP&HTTPS or HTTPS only**  
User can choose to use both HTTP and HTTPS concurrently, or just use HTTPS as the access method.
  
- **Port**  
Specify the TCP port for the HTTPS.

### 4.1.3 DDNS Service

#### **DDNS: Stands for Dynamic Domain Name Server**

Your Internet Service Provider (ISP) provides you at least one IP address which you use to connect to the Internet. The address you get may be static, meaning it never changes, or dynamic, meaning it's likely to change periodically. Just how often it changes, depends on your ISP. A dynamic IP address complicates remote access since you may not know what your current WAN IP address is when you want to access your device over the Internet.

One of the possible solutions to the dynamic IP address problem comes in the form of a dynamic DNS service.

A dynamic DNS service is unique because it provides a means of updating your IP address so that your listing will remain current when your IP address changes. There are several excellent DDNS services available on the Internet. One such service you can use is [www.DynDNS.org](http://www.DynDNS.org). You'll need to register with the service and set up the domain name of your choice to begin using it. Please refer to the home page of the service for detailed instructions or refer to Appendix G for more information.

If your device is connected to xDSL directly, you might need this feature. However, if your device is behind a NAT router, you will not need to enable this feature because your NAT router should take care of this job. As to xDSL environment, most of the users will use dynamic IP addresses. If users want to set up a web or a FTP server, then the Dynamic Domain Name Server is necessary.

Network	HTTPS	<b>DDNS</b>	PPPoE	Streaming	UPnP	Bonjour	ONVIF	IP Filter	IP Notification
---------	-------	-------------	-------	-----------	------	---------	-------	-----------	-----------------

DDNS	<input checked="" type="radio"/> Disable <input type="radio"/> Enable
Server Name	<input type="text" value="dyndns.org"/>
DDNS Host	<input type="text"/> (1 ~ 30 Digits)
User Name	<input type="text"/> (< 22 Digits)
Password	<input type="text"/> (< 22 Digits)

OK Cancel

- **DDNS:**  
To enable or disable the DDNS service here.

- **Server name:**  
Choose the built-in DDNS server.
- **DDNSHost:**  
The domain name is applied of this device.
- **User name:**  
The user name is used to log into DDNS.
- **Password:**  
The password is used to log into DDNS.

#### 4.1.4 PPPoE

##### **PPPoE: Stands for Point to Point Protocol over Ethernet**

A standard builds on Ethernet and Point-to-Point network protocol. It allows your device with xDSL or cable connects with broadband network directly, then your device can dial up and get a dynamic IP address. For more PPPoE and Internet configuration, please consult your dealer or ISP.

The device can directly connect to the xDSL, however, it should be setup on a LAN environment to program the PPPoE information first, and then connect to the xDSL modem. Power on again, then the device will dial on to the ISP connect to the WAN through the xDSL modem.

The procedures are

- Connect to a LAN by DHCP or Fixed IP
- Access the device; enter Setting → Network → PPPoE as below

Network	HTTPS	DDNS	PPPoE	Streaming	UPnP	Bonjour	ONVIF	IP Filter	IP Notification
---------	-------	------	-------	-----------	------	---------	-------	-----------	-----------------

PPPoE	<input checked="" type="radio"/> Disable <input type="radio"/> Enable
User Name	<input type="text"/> (< 65 Digits)
Password	<input type="text"/> (< 65 Digits)
IP Address	<input type="text"/> (readonly)
Subnet Mask	<input type="text"/> (readonly)
Gateway	<input type="text"/> (readonly)
Status	<input type="text"/> (readonly)

OK Cancel

- **PPPoE:**  
To enable or disable the PPPoE service here.
- **User name:**  
Type the user name for the PPPoE service which is provided by the ISP.
- **Password:**  
Type the password for the PPPoE service which is provided by the ISP.
- **IP address, Subnet mask, and Gateway (read only):**  
Shows the IP information got from PPPoE server site.
- **Status:**  
Shows the Status of PPPoE connection.

## 4.1.5 Streaming

RTSP is a streaming control protocol, and a starting point for negotiating transports such as RTP, multicast and Unicast, and for negotiating codecs. RTSP can be considered a "remote control" for controlling the media stream delivered by a media server. RTSP servers typically use RTP as the protocol for the actual transport of audio/video data.

- **RTSP Port:**

Choose the RTSP port. The RTSP protocol allows a connecting client to start a video stream. Enter the RTSP port number to use. The default value is 554.

- **RTP Port:**

Specify the range of transmission port number of video stream. The default range is 50000 to 50999. User can specify a number between 1024 and 65535.

Network	HTTPS	DDNS	PPPoE	Streaming	UPnP	Bonjour	ONVIF	IP Filter	IP Notification
---------	-------	------	-------	-----------	------	---------	-------	-----------	-----------------

RTSP Port	<input type="text" value="554"/>	(554 ~ 65535)	<input type="button" value="Test"/>	
RTP Port	<input type="text" value="50000"/>	~	<input type="text" value="50999"/>	(1024 ~ 65535)

<input type="button" value="OK"/>	<input type="button" value="Cancel"/>
-----------------------------------	---------------------------------------

### 4.1.6 UPnP

UPnP is short for Universal Plug and Play, which is a networking architecture that provides compatibility among networking equipment, software, and peripherals. This device is an UPnP enabled Network Camera. If your operating system is UPnP enabled, the device will automatically be detected and a new icon will be added to “My Network Places.” If you do not want to use the UPnP functionality, it can be disabled.

In addition, this device also provides UPnP IGD function for NAT traversal easily. Use NAT traversal when your device is located on an intranet (LAN) and you wish to make it available from the other (WAN) side of a NAT router. With NAT traversal properly configured, all HTTP traffic to an external HTTP port in the NAT router will be forwarded to the device.

Network	HTTPS	DDNS	PPPoE	Streaming	<b>UPnP</b>	Bonjour	ONVIF	IP Filter	IP Notification
---------	-------	------	-------	-----------	-------------	---------	-------	-----------	-----------------

UPnP	<input type="radio"/> Disable <input checked="" type="radio"/> Enable
Friendly Name	<input type="text" value="AirCam OD-2025POE"/> (readonly)
UPnP NAT Traversal	<input type="radio"/> Disable <input checked="" type="radio"/> Enable
Port Range	<input type="text" value="32768"/> ~ <input type="text" value="65535"/> (1 ~ 65535)
External IP Address	<input type="text"/> (readonly)

- **UPnP:**  
To enable or disable the UPnP service here.
- **Friendly Name:**  
Shows the friendly name of this device here.

- **UPnP NAT Traversal**

When enabled, the device will attempt to configure port mapping in a NAT router on your network, using UPnP™. Note that UPnP™ must be enabled in the NAT router first.

- **Port Range:**

The port range will open in NAT router.

- **External IP address:**

Show the IP address and port for WAN access through Internet. If NAT traversal is configured successfully, user can use this IP address and port to access this device. The external IP address is not shown in case NAT traversal function is failed.

#### **4.1.7 Bonjour**

Bonjour, also known as zero-configuration networking, enables automatic discovery of computers, devices, and services on IP networks. Bonjour uses industry standard IP protocols to allow devices to automatically discover each other without the need to enter IP addresses or configure DNS servers. Specifically, Bonjour enables automatic IP address assignment without a DHCP server, name to address translation without a DNS server, and service discovery without a directory server. Bonjour is an open protocol which Apple has submitted to the IETF as part of the ongoing standards-creation process.

- **Bonjour:**

To enable or disable the Bonjour service here.

- **Friendly Name:**

Shows the friendly name of this device here.

Network	HTTPS	DDNS	PPPoE	Streaming	UPnP	Bonjour	ONVIF	IP Filter	IP Notification
---------	-------	------	-------	-----------	------	---------	-------	-----------	-----------------

Bonjour  Disable  Enable

Friendly Name  (readonly)

OK Cancel

#### 4.1.8 ONVIF

This IP camera support ONVIF V1.0, V1.01 and V1.02. If you need to use ONVIF as your protocol for connecting the IP camera with your backend management system, you can enable this protocol in this page.

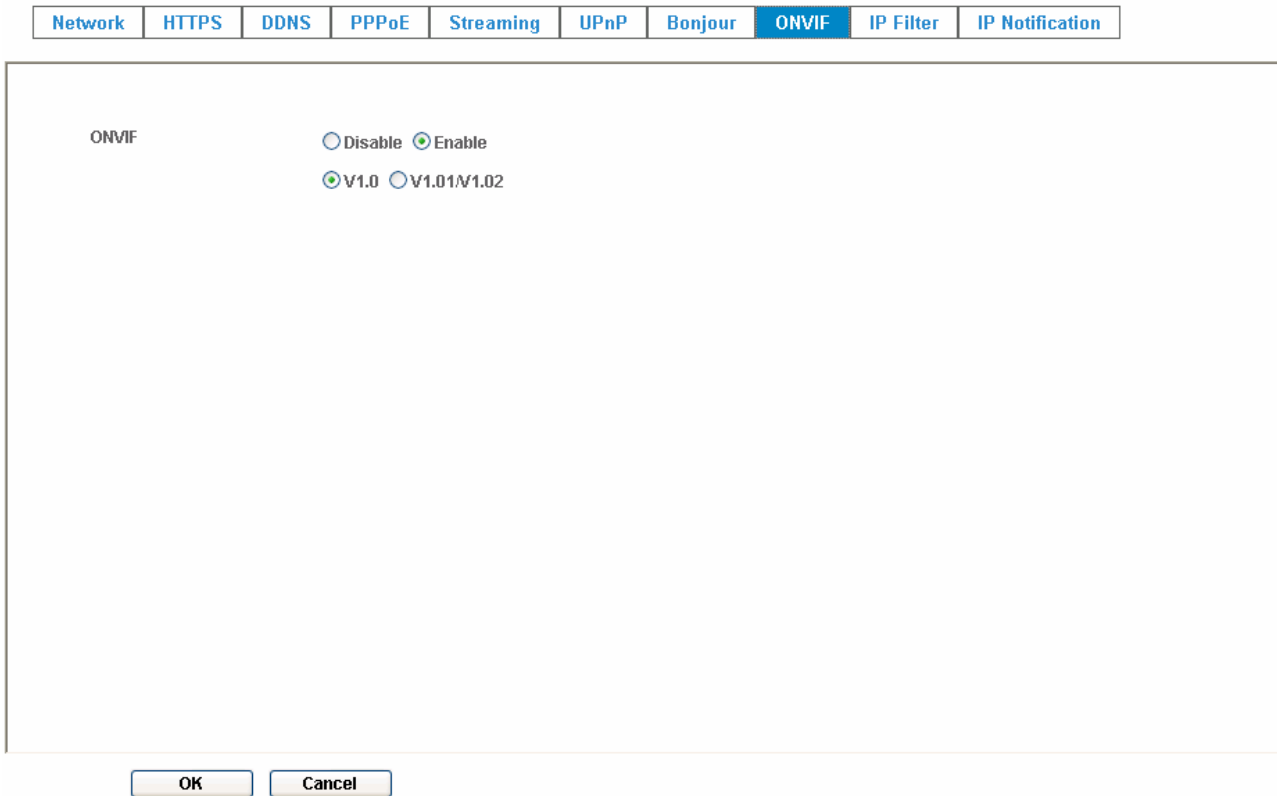

- **ONVIF:**  
To enable or disable this protocol.
- **Version Selection:**  
Choose the version of the protocol you wanted to use.

#### 4.1.9 IP Filter

You can enter different user's IP address which are allowing enter or denying by the device.

- **IP Filter:**  
To enable or disable the IP filter function here.
- **IP Filter Policy:**  
Choose the filter policy where is denying or allowing.

Network HTTPS DDNS PPPoE Streaming UPnP Bonjour ONVIF **IP Filter** IP Notification

IP Filter  Disable  Enable

IP Filter Policy  Deny  Allow

Filter IP List

Filter IP
<input type="text"/>

#### 4.1.10 IP Notification

In case the IP address is changed, system is able to send out an email to alert someone if the function is enabled.

- SMTP Notification (e-mail):  
If enable this function, then the “**Send to**” and “**Subject**” fields need to be filled.
- Send To:  
Type the receiver’s e-mail address. This address is used for reply mail.
- Subject:  
Type the subject/title of the E-mail.

Network	HTTPS	DDNS	PPPoE	Streaming	UPnP	Bonjour	ONVIF	IP Filter	IP Notification
SMTP Notification(email) <input checked="" type="radio"/> Disable <input type="radio"/> Enable Send To <input type="text"/> (< 129 Digits) Subject <input type="text" value="IP notification"/> (< 65 Digits) TCP Notification <input checked="" type="radio"/> Disable <input type="radio"/> Enable TCP Server <input type="text"/> (< 65 Digits) TCP Port <input type="text"/> (1 ~ 65535) Message <input type="text"/> (< 65 Digits) HTTP Notification <input checked="" type="radio"/> Disable <input type="radio"/> Enable URL <input type="text" value="http://"/> (< 64 Digits) HTTP Login Name <input type="text"/> (< 22 Digits) HTTP Login Password <input type="text"/> (< 22 Digits) Proxy Address <input type="text"/> (< 129 Digits) Proxy Port <input type="text"/> (1 ~ 65535) Proxy Login Name <input type="text"/> (< 22 Digits) Proxy Login Password <input type="text"/> (< 22 Digits)									
<input type="button" value="OK"/> <input type="button" value="Cancel"/>									

- TCP Notification:  
 If enable this function, then the “**TCP Server**“, “**TCP Port**”, and “**Message**” fields need to be filled.
- TCP Server:  
 Type the server name or the IP address of the TCP server.
- TCP Port:  
 Set port number of TCP server.
- Message:  
 The message will be sent to FTP server.
- HTTP Notification:  
 If enable this function, then the fields below need to be filled.
- URL:  
 Type the server name or the IP address of the HTTP server.

- HTTP Login name:  
Type the user name for the HTTP server.
  
- HTTP Login Password:  
Type the password for the HTTP server.
  
- Proxy Address:  
Type the server name or the IP address of the HTTP Proxy.
  
- Proxy Port:  
Set port number of Proxy.
  
- Proxy Login name:  
Type the user name for the HTTP Proxy.
  
- Proxy Login Password:  
Type the password for the HTTP Proxy.
  
- Custom parameter:  
User can set specific parameters to HTTP server.
  
- Message:  
The message will be sent to HTTP server.

## 4.2 Camera: Adjust Camera Parameters

Use this menu to set the functions of the camera parameters of the device.

### 4.2.1 Picture

Picture
Privacy Mask
PTZ Setting
Preset Setting
Tour Setting

Rotation: Normal

White Balance: Auto

Exposure Control:  Auto  Hold

Maximum Exposure Time: 1/30 S

Power Frequency:  50Hz  60Hz

Color Level:  70 (0 ~ 100)

Hue:  50 (0 ~ 100)

Brightness:  50 (0 ~ 100)

Contrast:  50 (0 ~ 100)

Sharpness:  50 (0 ~ 100)

De-Noise: Off

Default Settings: Default Settings



OK
Cancel

- Rotation: Turn the "Mirror" and "Vertical Flip" On or OFF. The image will be overturned as below.

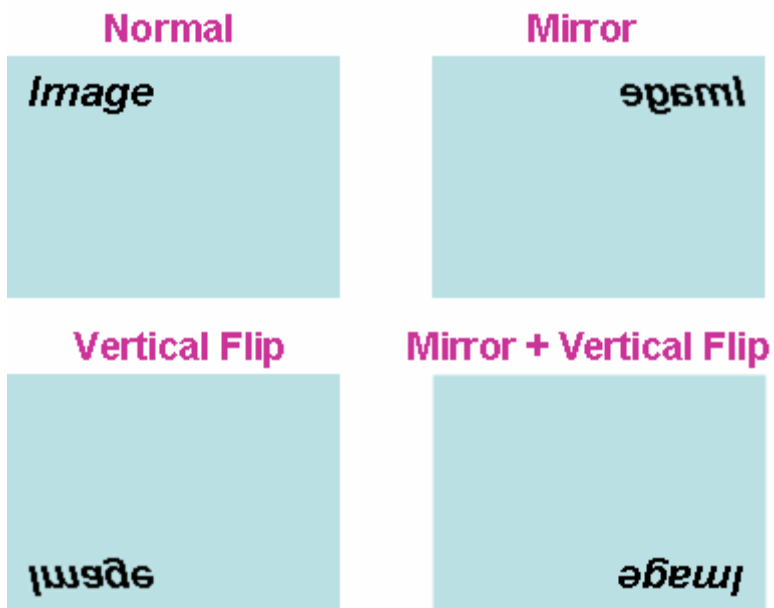

- **White Balance:**  
Auto: will adjust the white balance automatically.  
Hold: will hold the white balance.
  
- **Exposure Control:**  
Auto: will adjust the internal gain automatically.  
Hold: will hold the internal gain.
  
- **Color Level:**  
Large value will be colorful.
  
- **Hue:**  
Increase or decrease the hue of the video.
  
- **Brightness:**  
Large value will brighten camera.
  
- **Sharpness:**  
Large value will sharpen camera.
  
- **Contrast:**  
Large value will contrast camera heavily.
  
- **Default Setting:**  
Click on this button if you need restore the value to default state.

### 4.2.2 Privacy Mask

User can add privacy mask for avoiding some critical areas been seeing by others.

Picture
Privacy Mask
PTZ Setting
Preset Setting
Tour Setting



▼  
Add Delete

Name

Level

0 (Black) ▼

Save

- **Add or Delete:**  
To add or delete the privacy mask windows. User can add up to 8 windows as privacy zone. By dragging mouse on the image, you can change the position and size of the selected privacy mask windows accordingly.
  
- **Name:**  
Name of the specified motion window
  
- **Level:**  
Select the color of the mask in gray level.

### 4.2.3 PTZ Setting

User can configure the RS-485 protocol in this page. RS-485 is an communication interface, in most situation, it is to be used for controlling the scanner.

Picture Privacy Mask **PTZ Setting** Preset Setting Tour Setting

Camera Protocol	<input type="text" value="Pelco-D"/>
Camera Address	<input type="text" value="none"/>
Baud rate	<input type="text" value="Pelco-D"/>

none  
Pelco-D  
Pelco-P  
Airlive  
EPTZ  
VC  
K-ZM23E1N  
Airlive-PTZ  
Honeywell

OK Cancel

- **Camera Protocol:**  
This device can connect to a PTZ camera or speed dome camera and controls them thru RS485 interface.
- **Camera Address:**  
This is the camera ID set in PTZ camera or speed dome camera. Note that please DO NOT change the default value if unnecessary. If so, user needs to check and set value properly for both sides.
- **Baud rate:**  
This is the communication speed between network module and P/T scanner.

## 4.2.4 Preset Setting

This page provides the edit tool to modify or delete the “Preset Setting” item by item.

[Picture](#) [Privacy Mask](#) [PTZ Setting](#) [Preset Setting](#) [Tour Setting](#)

Preset Number	Preset Name	Home Position

Preset List	
Preset Number	<input type="text"/>
Preset Name	<input type="text"/>
Home Position	<input type="radio"/> Enable <input checked="" type="radio"/> Disable
<input type="button" value="Modify"/> <input type="button" value="Delete"/>	

### 4.2.5 Tour Setting

Up to 128 positions can be preset, and the camera can be programming to move to the preset position sequentially.

Picture
Privacy Mask
PTZ Setting
Preset Setting
Tour Setting

Tour Number	Tour Name	Running	Sequence	Preset Name	Wait Time

Tour Name	<input style="width: 90%;" type="text"/>
Running	<input type="radio"/> Enable <input checked="" type="radio"/> Disable
<input type="button" value="Add"/> <input type="button" value="Modify"/> <input type="button" value="Delete"/>	

- **Tour Name:**  
The group name of the sequence of camera tour. The maximum number of camera tour is 16.
  
- **Running:**  
Enable or disable this camera tour.
  
- **Preset:**  
Set the sequence of the tour. Maximum 16 points can be assigned. The selected preset position is added in the Sequence list from 1 to 16.
  
- **Wait Time:**  
Type a period of time during which the camera is to stay at each preset point, between 0 to 36000 seconds.

To use the camera tour function, user must preset some camera positions first.

## 4.3 System: Configure and Maintain System

Use this menu to perform the principal settings of the device.

### 4.3.1 System

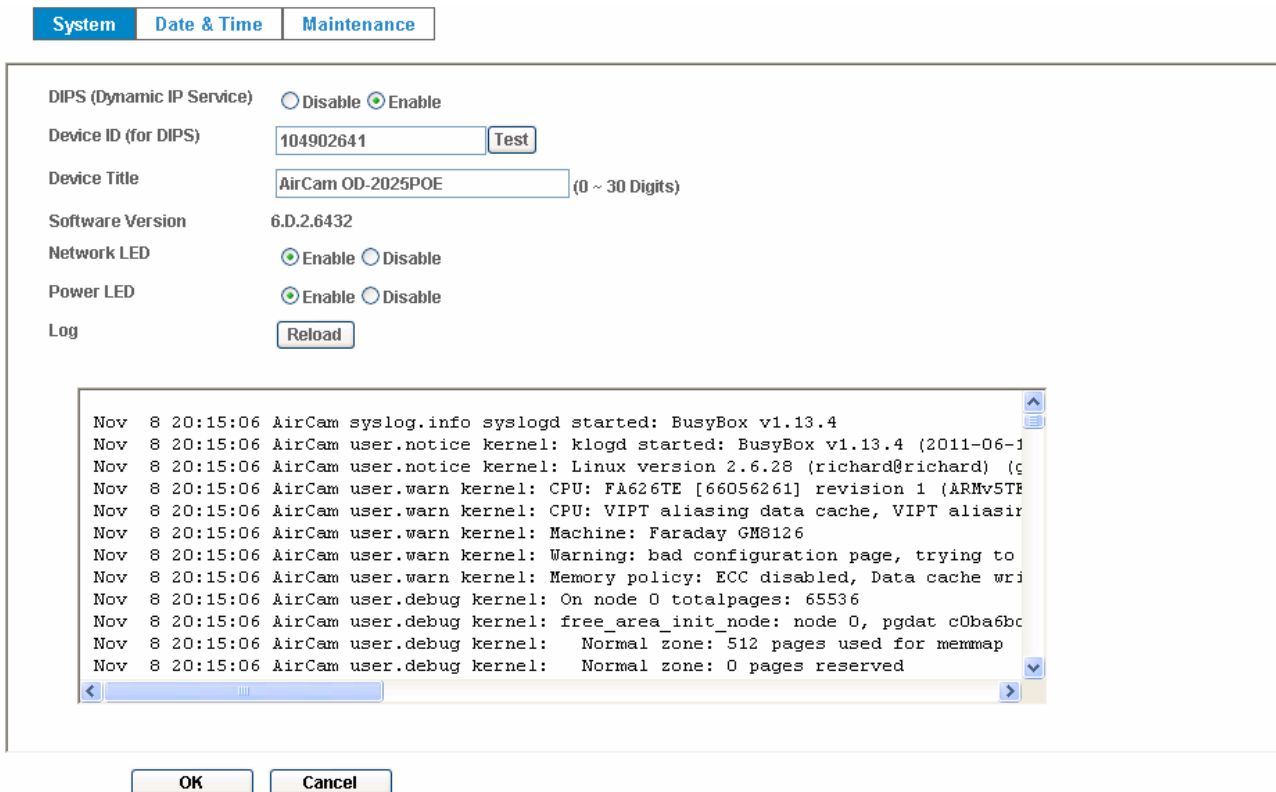

- **DIPS (Dynamic IP Service):**  
To enable or disable the DIPS® (Dynamic IP Service) function.
- **Device ID (for DIPS):**  
It's a unique number of each device for identification and this ID is used for DIPS.

In the Appendix G, it describes how to locate your device from Internet by DDNS service. However, we provide another easier way to do the same job called Dynamic IP Service, DIPS®.

To use this service, just follow four steps below:

- (1) Enable DIPS function of the device
- (2) Check your Device ID from this page. This is a unique number for each device.

(3) If your device is behind a NAT router, please configure your device properly. You could refer to section “Install the Camera behind a NAT Router” above. You only need to do this job one time.

(4) Visiting our company’s web site, you can find DIPS service page.

- **Device Title:**

You can enter the name of this unit here. It’s very useful to identify the specific device from multiple units. The information will be shown on IPWizard II once the device is found.

- **Software Version:**

This information shows the software version of the device.

- **Network LED:**

To turn on or off Network LED.

- **Power LED (Wireless LED):**

To turn on or off Power LED (wireless LED if WLAN model).

- **Log:**

User can check the system log information of the device, including the Main Info, Appended Info, Operator IP, and so on ...

- **Reload:**

Click this button; user can refresh the log information of the device.

### 4.3.2 Date & Time

You can setup the device or make it synchronized with PC or remote NTP server. Also, you may select your time zone in order to synchronize time locally.

- **Server Date & Time:**

Displays the date and time of the device.

- **PC Time:**

Displays the date and time of the connected PC.

- **Adjust:**

- Synchronize with PC:

Click this option to enable time synchronization with PC time.

- Manual setting:

Click this option to set time and date manually.

- Synchronize with NTP:

Click this option if you want to synchronize the device's date and time with those of time server called NTP server (Network Time Protocol).

- NTP Server:

Type the host name or IP address or domain name of the NTP server.

- NTP sync. Interval:

Select an interval between 1 and 23 hours at which you want to adjust the device's time referring to NTP server

- Time zone:

Set the time difference from Greenwich Mean Time in the area where the device is installed.

- Daylight Saving:

Disable or enable the daylight saving adjustment.

System
Date & Time
Maintenance

Server Date & Time

PC Time

Adjust

Synchronize with PC

Manual setting : Date :    Time :  :  :

Synchronize with NTP

NTP Server

NTP Sync. Interval

Timezone

Daylight Saving  Disable  Enable

Daylight Saving StartTime   :  :

Daylight Saving StopTime   :  :

Daylight Saving Offset   :  :

### 4.3.3 Maintenance

- **Hard Factory Default (Include the network setting):**  
Recall the device hard factory default settings. Note that click this button will reset all device's parameters to the factory settings (including the IP address).
- **Factory Default (Except the network setting):**  
The unit is restarted and most current settings are reset to factory default values. This action will not reset the network setting.
- **Backup Setting:**  
To take a backup of all of the parameters, click this button. If necessary, it will then be possible to return to the previous settings, if settings are changed and there is unexpected behavior.
- **Restore Setting:**  
Click the "Browse" button to locate the saved backup file and then click the "**Restore Setting**" button. The settings will be restored to the previous configuration.

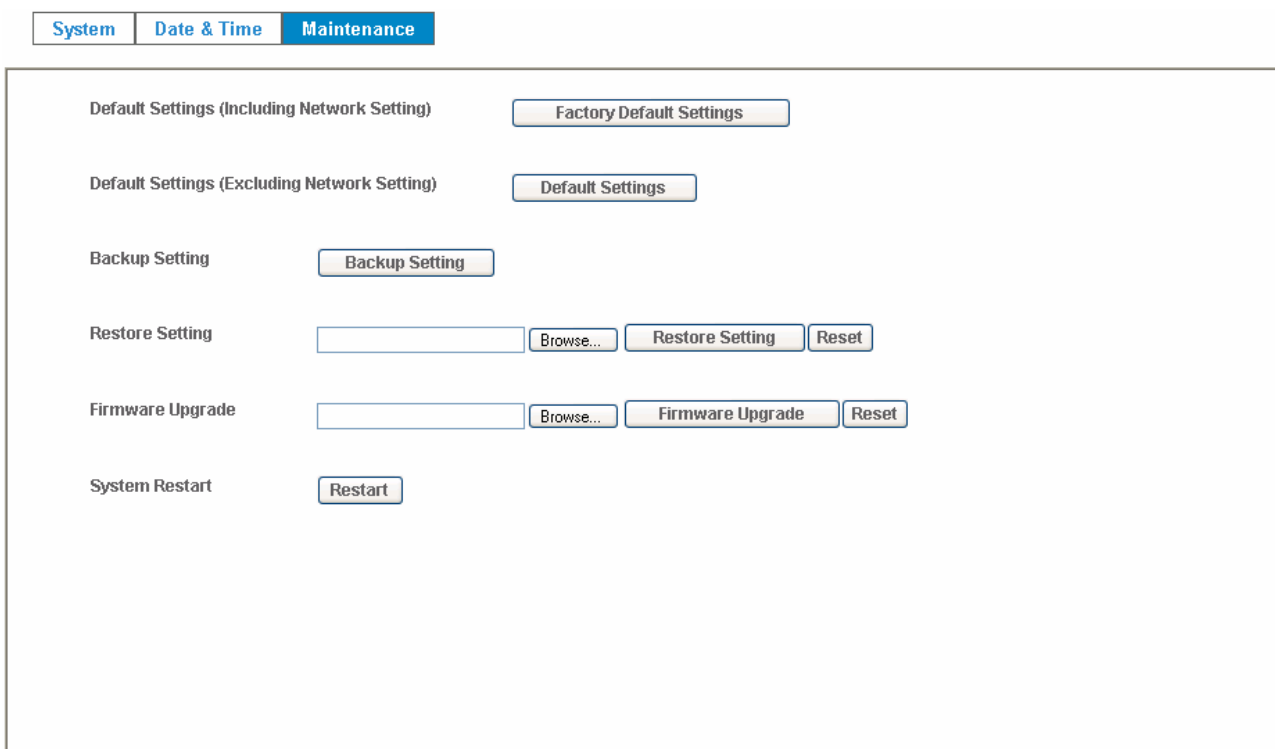

The screenshot shows the Maintenance settings page with the following options:

- Default Settings (Including Network Setting):** Factory Default Settings
- Default Settings (Excluding Network Setting):** Default Settings
- Backup Setting:** Backup Setting
- Restore Setting:** [Browse...] Restore Setting Reset
- Firmware Upgrade:** [Browse...] Firmware Upgrade Reset
- System Restart:** Restart

- **Firmware Upgrade:**  
The device supports new firmware upgrade (the software that controls the operation in the device). Please contact your dealer for the latest version if necessary.

Download the latest firmware file from our website or your dealer. Unzip this firmware file to binary file and store it into your PC. Then follow the steps as bellows carefully:

1. Close all other application programs which are not necessary for firmware update.
2. **Make sure that only you access this device while firmware updating.**
3. Disable Motion Detection function.
4. Click “**Browse**” button. Select the Firmware binary file. ( **Note that it must make sure that the Firmware only applies to this device, once update, it will be burned into FLASH ROM of system.**)
5. Once the firmware file was selected, click “**Firmware Upgrade**” button.
6. The upgrade progress information will be displayed. Once the uploading process completed, the device will reboot the system automatically.
7. Please wait for timer countdown, and then you can use IPWizard II to search the device again.

**Warning!!!** The download firmware procedure can not be interrupted. If the power and/or network connection are broken during the download procedure, it might possibly cause serious damage to the device.

**Strongly suggest that DO NOT upgrade firmware via Wireless LAN due to high error rate possibly and don't allow any other clients to access this unit during updating procedure.**

**Be aware that you should not turn off the power during updating the firmware and wait for finish message.**

**Furthermore, the firmware upgrade procedure always is risk and do not try to upgrade new firmware if it's not necessary.**

- System Restart:  
The device is restarted without changing any of the network settings. It means the IP address of the device will not change after firmware upgrade.

## 4.4 Video: Configure Profile

This device provides 2 modes of video profile. The first one is Mega-pixel mode which supports video resolution up to Mega-pixel. However the maximum frame rate of this mode is up to 15fps only. The second one is VGA mode which supports video resolution up to VGA but frame rate can be up to 30fps. User only can select either Mega-pixel or VGA mode to operate the camera. Switching Mega-pixel and VGA, the device will take time to reboot system.

### 4.4.1 Common

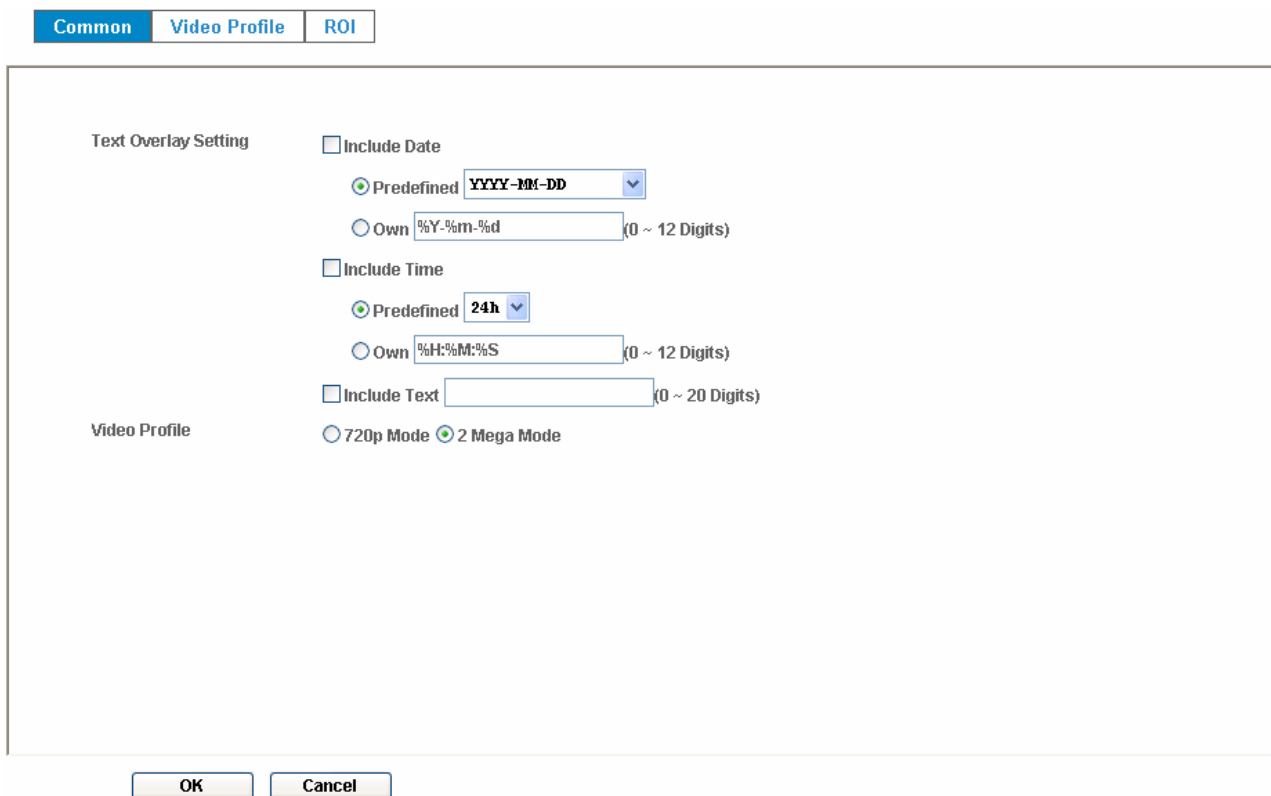

- **Text Overlay Setting:**  
There are some important information can be embedded into image, including date, time, and/or text.

#### **Video Profile:**

User can only choose either Mega or 2 Mega modes. Mega mode can serve H.264, MPEG4, and JPEG streams up to 1280x720 resolution simultaneously. On the other hand, 2 Mega mode, it can streams up to 1920x1080 resolution simultaneously.

### 4.4.2 Video Profile

Common
Video Profile
ROI

Name	Video Type	Resolution	Rate Control	Quality	Bitrate	Max Frame Rate	GOP Control	ROI	Multicast
Profile1	h264	1080p	EVBR	90	5000	30	30	no	no
Profile2	h264	1080p	EVBR	90	5000	30	30	no	no
Profile3	mjpeg	1080p	VBR	90	5000	6	1	no	no
Profile4(ROI)	h264	640x352	EVBR	90	2048	30	30	yes	no
Profile5(ROI)	h264	640x352	EVBR	90	2048	30	30	yes	no
Profile6	h264	640x352	EVBR	90	2048	30	30	no	no
Profile7	h264	640x352	EVBR	90	2048	30	30	no	no
Profile8	h264	640x352	EVBR	90	2048	30	30	no	no
Profile9	mjpeg4	640x352	EVBR	90	2048	30	30	no	no
Profile10	mjpeg	640x352	VBR	90	2048	6	1	no	no

Name:

Video Type: h264

Resolution: 1080p

ROI:  Yes  No

Rate Control: EVBR  
 Quality: 90  
 Max Bitrate: 10000 K bps 1024 ~ 15000

Max Frame Rate: 30

GOP Control: 30

Multicast:  Enable  Disable

Multicast Video: IP Address 239.198.97.181 Port 0 (0 means auto, 1024 ~ 65534)

- **Name:**  
Assign a name to the selected profile.
  
- **Video Type:**  
Video codec of the selected video profile.
  
- **Resolution:**  
Resolution of the selected video profile.
  
- **ROI:**  
Assign the selected profile as a ROI stream or not.
  
- **Rate Control:**  
Defines the rate control method of this profile. There are four options: Constant Bit Rate (CBR), Variable Bit Rate (VBR), Enhanced Constant Bit Rate (ECBR), and Enhanced Variable Bit Rate (EVBR). For CBR, the video bit rate is between low to high bandwidth based on different resolutions. User can set the desired bit rate to match the limitation of bandwidth. For VBR, user should choose the quality level to set the video quality rather than bit rate. The quality level is between 1 and 100. The higher value can reach the better quality but of course will consume higher bandwidth.

- **Max Frame Rate:**  
Defines the targeted frame rate of this profile. For example, set the frame rate to 15 fps, then the image will be updated for 15 frames per second as possible. User need to set reasonable max frame rate versus video quality under the limited bandwidth.
- **GOP Control:**  
Defines the Intra/Inter-frame (I/P) ratio of this profile. For example, set the GOP to 30, then the video stream will have one Intra-frame every 30 frames.

### 4.4.3 ROI

ROI means Region of Interest. Use this page to specify ROI window which ROI is QVGA resolution.

Common Video Profile ROI

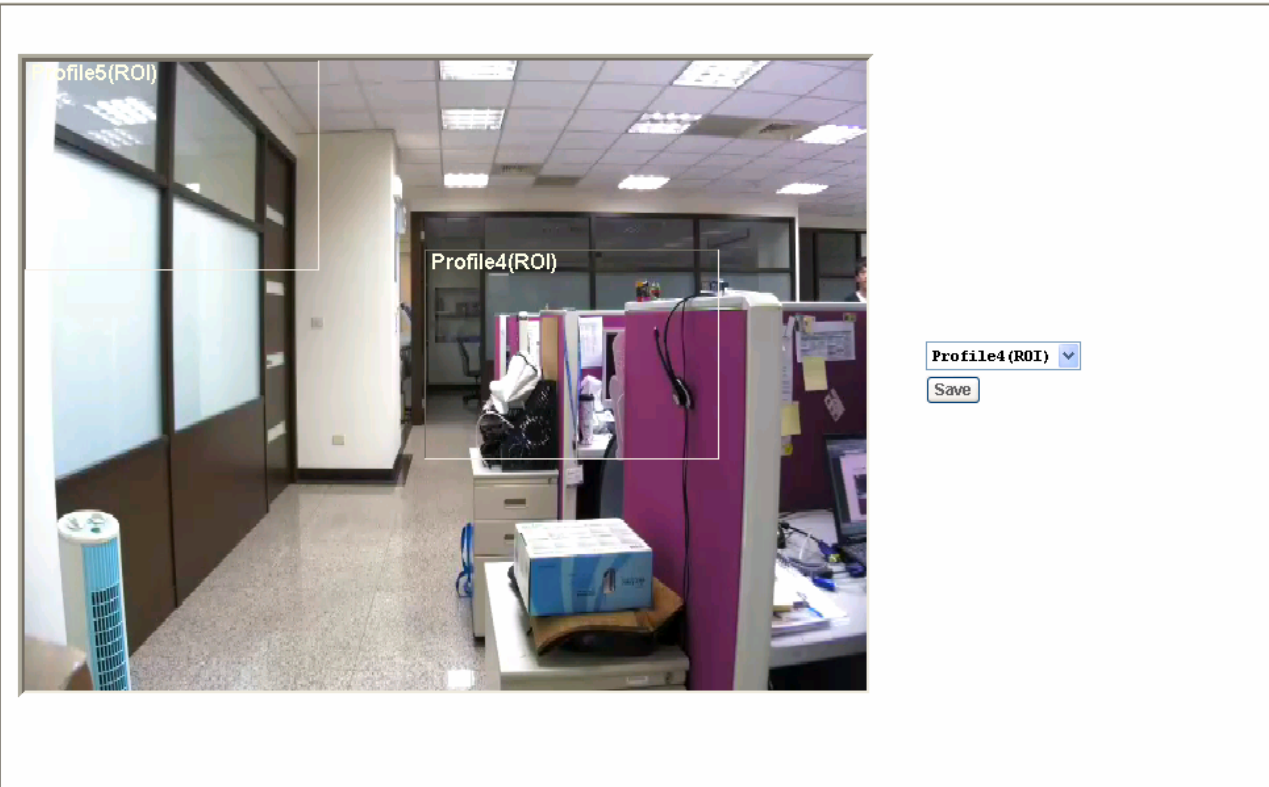

Profile5(ROI)

Profile4(ROI)

Profile4(ROI) ▼

Save

## 4.5 Audio: Audio Parameters

Setting

Audio	<input type="radio"/> Disable <input checked="" type="radio"/> Enable
Mute While PT	<input checked="" type="radio"/> Disable <input type="radio"/> Enable
Audio Mode	<input checked="" type="radio"/> Simplex <input type="radio"/> Full duplex
Input Gain	80 ▼
Output Gain	80 ▼

OK Cancel

- **Audio:**  
To enable or disable audio function
- **Mute While PT:**  
Mute the audio while pan and/or tilt motion
- **Audio Mode:**  
To select Simplex or Full duplex (2-way audio) mode
- **Input Gain:**  
To adjust gain of input audio
- **Output Gain:**  
To adjust gain of output audio

## 4.6 User: Manage User Name, Password and Login Privilege

Use this menu to add, update, or remove the usernames and passwords of the Administrator and viewer.

**Setting**

Viewer Login  Anonymous  Only users in database

User Name	Access Right	PTZ Control
admin	administrator	yes

User List	
User Name	<input type="text"/> (1 ~ 20 Digits)
Password	<input type="text"/> (0 ~ 20 Digits)
Verify Password	<input type="text"/> (0 ~ 20 Digits)
Access Right	<input type="radio"/> Administrator <input checked="" type="radio"/> Viewer
PTZ Control	<input type="radio"/> Enable <input checked="" type="radio"/> Disable
<input type="button" value="Add"/> <input type="button" value="Modify"/> <input type="button" value="Delete"/>	

- **Viewer login:**  
Select “Anonymous” to allow any one viewing the video once connected. Otherwise, only users in database can view the video after login.
- **Access Right:**  
Administrator can access every function in this device. However, Viewers only can view the video and access limited function.
- **PTZ Control:**  
Authorize this user to control PTZ function or not.
- **Add, update, and remove of Users account:**  
Manage the user’s account of viewer user.

## 4.7 E-Mail: Setup E-Mail Configuration

You may setup SMTP mail parameters for further operation of Event Schedule. That's, if users want to send the alarm message out, it will need to configure parameters here and also add at least one event schedule to enable event triggering.

Setting

SMTP Server	<input type="text"/>	<small>(&lt; 129 Digits)</small>	<input type="button" value="Test"/>
SMTP Port	<input type="text" value="25"/>	<small>(1 ~ 65535)</small>	
SSL	<input checked="" type="radio"/> Disable <input type="radio"/> Enable		
SMTP Authentication	<input checked="" type="radio"/> Disable <input type="radio"/> Enable		
Authentication User Name	<input type="text"/>	<small>(&lt; 65 Digits)</small>	
Authentication Password	<input type="text"/>	<small>(&lt; 22 Digits)</small>	
E-mail From	<input type="text"/>	<small>(&lt; 129 Digits)</small>	
E-mail To	<input type="text"/>	<small>(&lt; 129 Digits)</small>	
E-mail Subject	<input type="text"/>	<small>(&lt; 65 Digits)</small>	

- **SMTP Server:**  
Type the SMTP server name or the IP address of the SMTP server.
- **Test:**  
Send a test mail to mail server to check this account is available or not.
- **SMTP Port:**  
Set port number of SMTP service.
- **SSL:**  
Enable SSL function or not.
- **SMTP Authentication:**  
Select the authentication required when you send an e-mail.  
  - Disable:** if no authentication is required when an e-mail is sent.
  - Enable:** if authentication is required when an e-mail is sent.

- Authentication User name:  
Type the user name for the SMTP server if **Authentication** is **Enable**.
- Authentication Password:  
Type the password for the SMTP server if **Authentication** is **Enable**.
- E-mail To:  
Type the receiver's e-mail address.
- E-mail From:  
Type the sender's E-mail address. This address is used for reply e-mails.
- E-mail Subject:  
Type the subject/title of the e-mail.

## 4.8 Object Detection: Setup Object Detection

Use this menu to specify motion detection window 1 to window 10 and set the conditions for detection while observing a captured image.

### Motion Detection

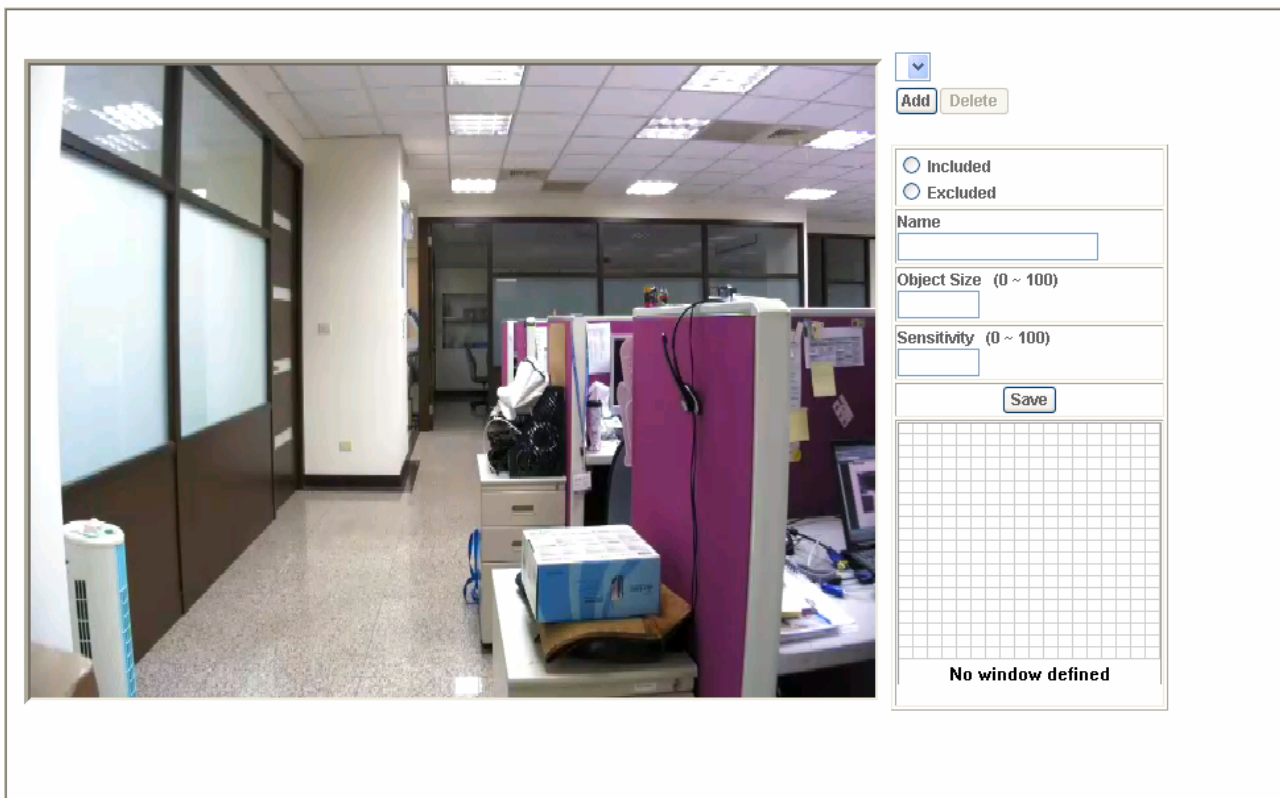

The screenshot displays the 'Motion Detection' configuration window. It features a live video feed of an office hallway on the left side. On the right side, there is a configuration panel with the following elements:

- A dropdown menu at the top left of the panel.
- 'Add' and 'Delete' buttons.
- Radio buttons for 'Included' and 'Excluded'.
- An input field labeled 'Name'.
- An input field labeled 'Object Size (0 ~ 100)'.
- An input field labeled 'Sensitivity (0 ~ 100)'.
- A 'Save' button.
- A large grid area at the bottom, currently empty, with the text 'No window defined' centered below it.

- **Add and Del:**  
To add or delete the motion windows. User can specify up to 10 Included and/or Excluded windows to monitor the video captured by this device. By dragging mouse on the image, you can change the position and size of the selected motion window accordingly.
- **Included or Excluded Window:**  
These windows can be specified as Included or Excluded type.  
**Included** windows target specific areas within the whole video image  
**Excluded** windows define areas within an Include window that should be ignored (areas outside Include windows are automatically ignored)
- **Name:**  
Name of the specified motion window.
- **Object Size:**  
Defines the object size of motion detection. The higher object size will only larger objects trigger motion detection. The lower object size will even small objects trigger motion detection too. Generally speaking, the smaller size will be easier to trigger event.
- **Sensitivity**  
Defines the sensitivity value of motion detection. The higher value will be more sensitivity.

## 4.9 Event Server: Setup FTP/TCP/HTTP/SAMBA Server Configuration

### 4.11.1 FTP Server

You may setup FTP parameters for further operation of Event Schedule. That's, if users want to send the alarm message to an FTP server, it will need to configure parameters here and also add at least one event schedule to enable event triggering as SMTP.

FTP Server		TCP Server	HTTP Server	SAMBA Server										
Name	FTP Server	FTP Port	FTP Path											
<table border="1"> <thead> <tr> <th>Name</th> <th>FTP Server</th> <th>FTP Port</th> <th colspan="2">FTP Path</th> </tr> </thead> <tbody> <tr> <td colspan="5" style="height: 100px;"> </td> </tr> </tbody> </table>					Name	FTP Server	FTP Port	FTP Path						
Name	FTP Server	FTP Port	FTP Path											
Name	<input type="text"/>	(< 22 Digits)												
FTP Server	<input type="text"/>	(< 65 Digits)	<input type="button" value="Test"/>											
FTP Login Name	<input type="text"/>	(< 22 Digits)												
FTP Login Password	<input type="text"/>	(< 22 Digits)												
FTP Port	<input type="text" value="21"/>	(1 ~ 65535)												
FTP Path	<input type="text"/>	(< 65 Digits)												
FTP Passive Mode	<input checked="" type="radio"/> Disable <input type="radio"/> Enable													

- **Name:**  
 User can specify multiple FTP paths as wish. Therefore, user needs to specify a name for each FTP setting.
- **FTP Server:**  
 Type the server name or the IP address of the FTP server.
- **Test:**  
 Check the FTP server whether this account is available or not.
- **FTP Login name:**  
 Type the user name for the FTP server.
- **FTP Login Password:**  
 Type the password for the FTP server.
- **FTP Port:**  
 Set port number of FTP service.
- **FTP Path:**  
 Set working directory path of FTP server.

- **FTP Passive Mode:**  
Select passive or active mode connecting to FTP server.

### 4.11.2 TCP Server

In addition to send video file to FTP server, the device also can send event message to specified TCP server.

FTP Server
TCP Server
HTTP Server
SAMBA Server

Name	TCP Server	TCP Port

Name		(< 22 Digits)
TCP Server		(< 65 Digits) <span style="border: 1px solid #ccc; padding: 2px 5px;">Test</span>
TCP Port		(1 ~ 65535)

Add
Modify
Delete

- **Name:**  
User can specify multiple TCP servers as wish. Therefore, user needs to specify a name for each TCP server setting.
- **TCP Server:**  
Type the server name or the IP address of the TCP server.
- **TCP Port:**  
Set port number of TCP server.

### 4.11.3 HTTP Server

The device also can send event message to specified HTTP server.

FTP Server
TCP Server
HTTP Server
SAMBA Server

Name	Proxy Address
Name	<input type="text" value=""/> (< 22 Digits)
URL	<input type="text" value="http://"/> (< 129 Digits) <input type="button" value="Test"/>
HTTP Login Name	<input type="text" value=""/> (< 22 Digits)
HTTP Login Password	<input type="password" value=""/> (< 22 Digits)
Proxy Address	<input type="text" value=""/> (< 129 Digits)
Proxy Login Name	<input type="text" value=""/> (< 22 Digits)
Proxy Login Password	<input type="password" value=""/> (< 22 Digits)
Proxy Port	<input type="text" value=""/> (1 ~ 65535)

- **Name:**  
User can specify multiple HTTP servers as wish. Therefore, user needs to specify a name for each HTTP server setting.
- **URL:**  
Type the server name or the IP address of the HTTP server.
- **Test:**  
Check the HTTP server whether it is available or not.
- **HTTP Login name:**  
Type the user name for the HTTP server.
- **HTTP Login Password:**  
Type the password for the HTTP server.
- **Proxy Address:**  
Type the server name or the IP address of the HTTP Proxy.

- Proxy Login name:  
Type the user name for the HTTP Proxy.
- Proxy Login Password:  
Type the password for the HTTP Proxy.
- Proxy Port:  
Set port number of Proxy.

#### 4.11.4 SAMBA Server

The device also can send video stream to specified SAMBA server.

FTP Server
TCP Server
HTTP Server
SAMBA Server

Name	SAMBA Server	SAMBA Path

Name	<input type="text"/>	(< 22 Digits)
SAMBA Server	<input type="text"/>	(< 65 Digits) <input type="button" value="Test"/>
SAMBA Login Name	<input type="text"/>	(< 22 Digits)
SAMBA Login Password	<input type="password"/>	(< 22 Digits)
SAMBA Path	<input type="text"/>	(< 65 Digits)

- Name:  
User can specify multiple HTTP servers as wish. Therefore, user needs to specify a name for each HTTP server setting.
- SAMBA Server:  
Type the server name or the IP address of the SAMBA server.
- Test:  
Check the SAMBA server whether this account is available or not.

- SAMBA Login name:  
Type the user name for the SAMBA server.
- SAMBA Login Password:  
Type the password for the SAMBA server.
- SAMBA Path:  
Set working directory path of SAMBA server.

## 4.10 Event Schedule: Configure the Event Schedule

### 4.12.1 Setting

This menu is used to specify the schedule of Event or Schedule Trigger and activate the some actions provided by this device. Where the Schedule Trigger will be activated by user-define interval without event happened.

Setting
Record

Name	Enable	Type	Weekday	Start	Duration	Trigger by Prefix	Action
Name	<input type="text"/>						
Enable	<input checked="" type="radio"/> Yes <input type="radio"/> No						
Type	<input checked="" type="radio"/> Event Trigger <input type="radio"/> Schedule Trigger, Interval <input type="text" value="60"/> (Seconds)						
Enable Time	<input checked="" type="checkbox"/> Sun <input checked="" type="checkbox"/> Mon <input checked="" type="checkbox"/> Tue <input checked="" type="checkbox"/> Wed <input checked="" type="checkbox"/> Thu <input checked="" type="checkbox"/> Fri <input checked="" type="checkbox"/> Sat Start from <input type="text" value="0"/> : <input type="text" value="0"/> , Duration <input type="text" value="24"/> : <input type="text" value="0"/> ((max 168:00 hours))						
Trigger by	<input type="checkbox"/> Sensor <input checked="" type="checkbox"/> Active <input type="checkbox"/> Motion Area						
Record File Prefix	<input type="text"/> (0 ~ 20 Digits)						
Action	<input type="checkbox"/> Go <input checked="" type="radio"/> Preset <input type="radio"/> Tour <input type="checkbox"/> Voice Alert, Duration <input type="text" value="5"/> ( 0~86400 Seconds ) <input type="checkbox"/> Alarm Out, Duration <input type="text" value="5"/> ( 0~86400 Seconds ) <input type="checkbox"/> Send FTP <input type="checkbox"/> Send TCP <input type="checkbox"/> Send HTTP <input type="checkbox"/> Send E Mail						

Add
Modify
Delete

- Name:  
Name of the Event or Schedule.



- **Enable:**  
Enable or disable this Event or Schedule.
  
- **Type:**  
Event trigger or Schedule trigger.
  
- **Enable Time:**  
Define the feasible time slot.
  
- **Trigger by:**  
Select the triggered sources.
  
- **Action:**  
Define the actions once event triggered.

**Example 1:**

Send file to FTP server by motion triggered always:

1. Select event trigger
2. Enable time: start from 00:00 to 24:00 every day
3. Trigger by: Motion Area (Added in Object Detection page)
4. Action : Send FTP (Add in Event Server -> FTP Server page)

Setting
Record

Name	<input type="text"/>
Enable	<input checked="" type="radio"/> Yes <input type="radio"/> No
Type	<input checked="" type="radio"/> Event Trigger <input type="radio"/> Schedule Trigger, Interval <input type="text" value="60"/> ( Seconds)
Enable Time	<input checked="" type="checkbox"/> Sun <input checked="" type="checkbox"/> Mon <input checked="" type="checkbox"/> Tue <input checked="" type="checkbox"/> Wed <input checked="" type="checkbox"/> Thu <input checked="" type="checkbox"/> Fri <input checked="" type="checkbox"/> Sat Start from <input type="text" value="0"/> : <input type="text" value="0"/> , Duration <input type="text" value="24"/> : <input type="text" value="0"/> ((max 168:00 hours))
Trigger by	<input type="checkbox"/> Sensor <input type="text" value="Active"/> <input type="checkbox"/> Motion Area <input type="text" value=""/>
Record File Prefix	<input type="text"/> (0 ~ 20 Digits)
Action	<input type="checkbox"/> Go <input checked="" type="radio"/> Preset <input type="text" value=""/> <input type="radio"/> Tour <input type="text" value=""/> <input type="checkbox"/> Voice Alert, Duration <input type="text" value="5"/> ( 0~86400 Seconds ) <input type="checkbox"/> Alarm Out, Duration <input type="text" value="5"/> ( 0~86400 Seconds ) <input checked="" type="checkbox"/> Send FTP <input type="text" value="airftp"/> <input type="checkbox"/> Send TCP <input type="text" value=""/> <input type="checkbox"/> Send HTTP <input type="text" value=""/> <input type="checkbox"/> Send E-Mail <input type="checkbox"/> IR LEDs (Night Vision) <input type="text" value="Night Mode"/> <input type="text" value="0"/> ( 0~86400 Seconds ) <input type="checkbox"/> Send SD <input type="checkbox"/> Send Samba <input type="text" value=""/>

Add
Modify
Delete

**Example 2:**

Send file to E-Mail server by motion triggered from Friday 18:00 to Saturday 06:00

1. Select event trigger.
2. Enable time: start from Friday 18:00 and keep work in 12 hours, so it will stop on Saturday 06:00.
3. Trigger by : Motion Area (Added in Object Detection page)
4. Action : Send e-mail (Add in E-Mail page)
  - To email address: You need to input the receiver email address.
  - Subject: You could specify the email subject.
  - Message: You could specify the email content.

Setting		Record
Name	sent to mail	
Enable	<input checked="" type="radio"/> Yes <input type="radio"/> No	
Type	<input checked="" type="radio"/> Event Trigger <input type="radio"/> Schedule Trigger, Interval <input type="text" value="60"/> ( Seconds)	
Enable Time	<input checked="" type="checkbox"/> Sun <input checked="" type="checkbox"/> Mon <input checked="" type="checkbox"/> Tue <input checked="" type="checkbox"/> Wed <input checked="" type="checkbox"/> Thu <input checked="" type="checkbox"/> Fri <input checked="" type="checkbox"/> Sat Start from <input type="text" value="0"/> : <input type="text" value="0"/> , Duration <input type="text" value="24"/> : <input type="text" value="0"/> ((max 168:00 hours )	
Trigger by	<input type="checkbox"/> Sensor <input type="text" value="Active"/> <input type="checkbox"/> Motion Area <input type="text" value=""/>	
Record File Prefix	<input type="text"/> (0 ~ 20 Digits)	
Action	<input type="checkbox"/> Go <input checked="" type="radio"/> Preset <input type="text" value=""/> <input type="radio"/> Tour <input type="text" value=""/> <input type="checkbox"/> Voice Alert, Duration <input type="text" value="5"/> ( 0~86400 Seconds ) <input type="checkbox"/> Alarm Out, Duration <input type="text" value="5"/> ( 0~86400 Seconds ) <input type="checkbox"/> Send FTP <input type="text" value="airftp"/> <input type="checkbox"/> Send TCP <input type="text" value=""/> <input type="checkbox"/> Send HTTP <input type="text" value=""/> <input checked="" type="checkbox"/> Send E-Mail To email address <input type="text" value="wayne.wu@airlive.com"/> Subject <input type="text" value="Event"/> Message <input type="text" value="WN02600HD"/> <input checked="" type="checkbox"/> Attached file <input type="checkbox"/> IR LEDs (Night Vision) <input type="text" value="Night Mode"/> : <input type="text" value="0"/> ( 0~86400 Seconds )	
<input type="button" value="Add"/> <input type="button" value="Modify"/> <input type="button" value="Delete"/>		

**Example 3:**

Enable Voice Alert every 10-minute during 18:00 to 24:00 from Monday to Friday.

1. Type: Select schedule trigger and interval is 10-minute.
2. Enable time: Select Monday to Friday, and set start time from 18:00 and keep work in 6 hours.
3. Trigger by : You do not need to choose it, because this will be triggered every minute
4. Action : Voice Alert

Setting		Record
Name	sent to mail	
Enable	<input checked="" type="radio"/> Yes <input type="radio"/> No	
Type	<input checked="" type="radio"/> Event Trigger <input type="radio"/> Schedule Trigger, Interval <input type="text" value="60"/> ( Seconds)	
Enable Time	<input checked="" type="checkbox"/> Sun <input checked="" type="checkbox"/> Mon <input checked="" type="checkbox"/> Tue <input checked="" type="checkbox"/> Wed <input checked="" type="checkbox"/> Thu <input checked="" type="checkbox"/> Fri <input checked="" type="checkbox"/> Sat Start from <input type="text" value="0"/> : <input type="text" value="0"/> , Duration <input type="text" value="24"/> : <input type="text" value="0"/> ((max 168:00 hours))	
Trigger by	<input type="checkbox"/> Sensor <input type="text" value="Active"/> <input type="checkbox"/> Motion Area	
Record File Prefix	<input type="text"/> (0 ~ 20 Digits)	
Action	<input type="checkbox"/> Go <input checked="" type="radio"/> Preset <input type="radio"/> Tour <input checked="" type="checkbox"/> Voice Alert, Duration <input type="text" value="5"/> ( 0~86400 Seconds ) <input type="checkbox"/> Alarm Out, Duration <input type="text" value="5"/> ( 0~86400 Seconds ) <input type="checkbox"/> Send FTP <input type="text" value="airftp"/> <input type="checkbox"/> Send TCP <input type="checkbox"/> Send HTTP <input type="checkbox"/> Send E-Mail <input type="checkbox"/> IR LEDs (Night Vision) <input type="text" value="Night Mode"/> : <input type="text" value="0"/> ( 0~86400 Seconds ) <input type="checkbox"/> Send SD <input type="checkbox"/> Send Samba	
<input type="button" value="Add"/> <input type="button" value="Modify"/> <input type="button" value="Delete"/>		

### 4.12.2 Record

User can choose the type of record file for event or schedule application.

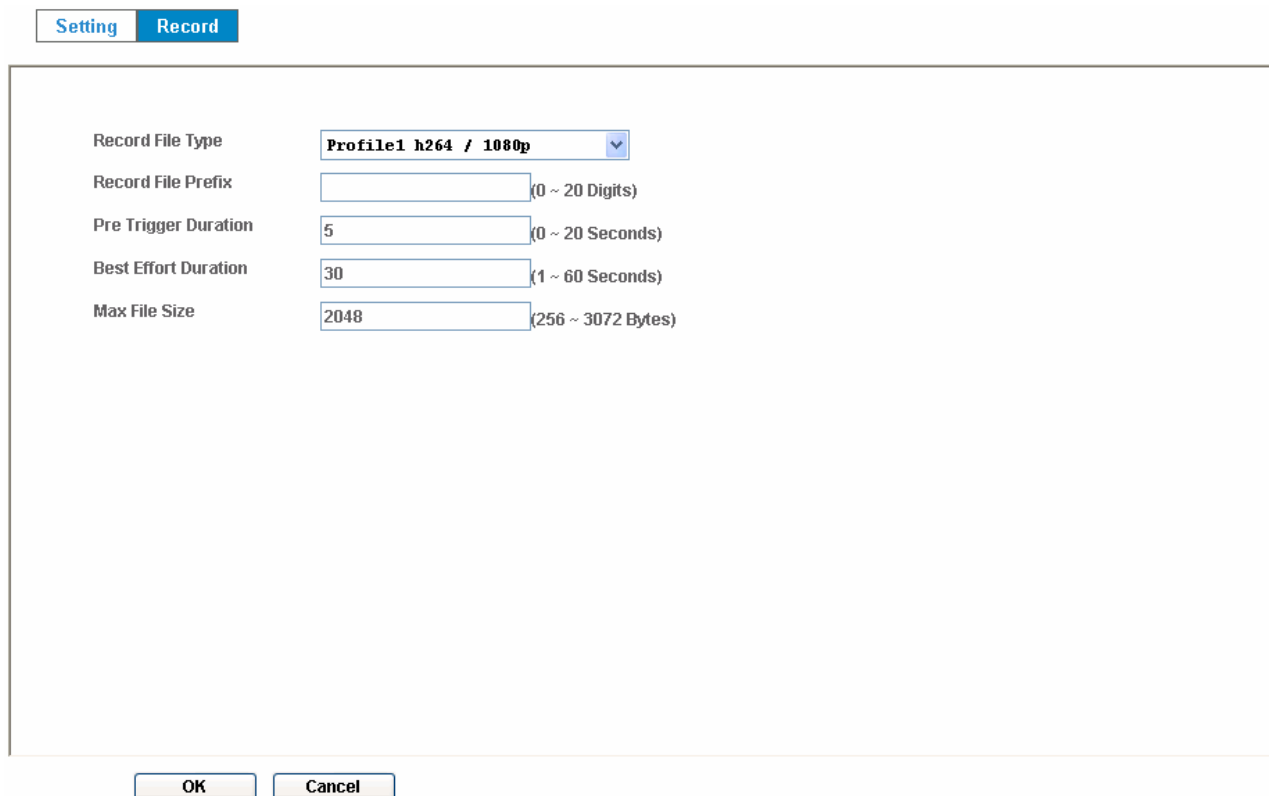

Record File Type	Profile1 h264 / 1080p
Record File Prefix	(0 ~ 20 Digits)
Pre Trigger Duration	5 (0 ~ 20 Seconds)
Best Effort Duration	30 (1 ~ 60 Seconds)
Max File Size	2048 (256 ~ 3072 Bytes)

- **Record File Type:**  
Choose JPEG, AVI-JPEG, or AVI-H.264 file format.
- **Record File Prefix:**  
Define the prefix of recorded filename.
- **JPEG Picture Numbers:**  
Define the picture numbers of JPEG to be sent out.
- **Pre-Trigger Duration:**  
Define the maximum duration of pre-alarm.
- **Post-Trigger Duration:**  
Define the maximum duration of post-alarm.
- **Max File Size:**  
Define the maximum buffer size of record file.

# 5

## Appendix

### Appendix A: Alarm I/O Connector

Some features of the Network Camera can be activated by the external sensor that senses physical changes in the area Network Camera is monitoring. These changes can include intrusion detection or certain physical change in the monitored area. For examples, the external sensor can be a door switch or an infrared motion detector. These devices are customer provided, and are available from dealers who carry surveillance and security products. Electrically, they must be able to provide a momentary contact closure.

This device provides a general I/O terminal block with one digital input and one output for device control. The pin 1 is located at the right side of terminal block from rear view. Pin 2 and 3 can be connected to an external sensor. The input voltage will be monitored from the initial state 'LOW'. If the external sensor need 12VDC power, it can connect to Pin1 (50mA maximum). The Alarm Output of pin 3 and 4 can be used to turn on or off the external device.

This Network Camera provides a general I/O terminal block as below:

Name	Cable Color	Function
12VDC	Brown/White	DC 12V (50mA maximum)
GND	Blue/White	GND
D+	Purple/White	RS485 data +
D-	Gray	RS485 data -
DI	Green/White	Digital signal input
DO	Orange/White	Digital signal output

User can refer to the schematic below to make a proper connection between I/O connector and external sensor and output device.

- **Explanation of External I/O Circuit Diagram:**

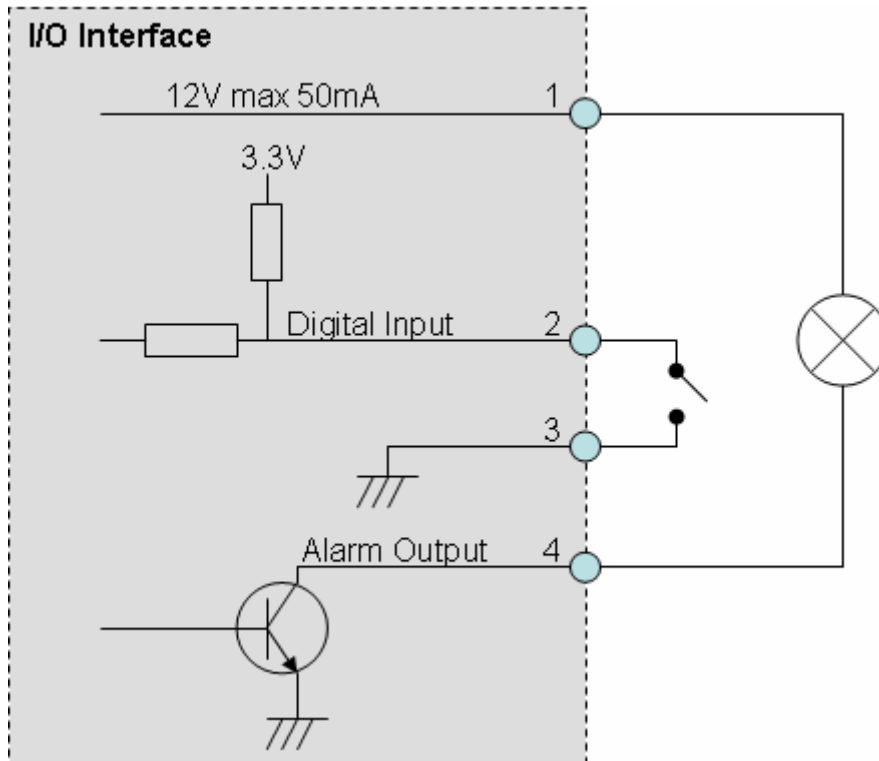

- **CAUTION!**

- THE LOW VOLTAGE/CURRENT CIRCUITS AND HIGH VOLTAGE/ CURRENT CIRCUITS ARE IN THE NETWORK CAMERA CIRCUIT. THE QUALIFIED ELECTRICIAN SHOULD DO THE WIRING NOT BY YOURSELF. INCORRECT WIRING COULD DAMAGE NETWORK CAMERA. YOU COULD RECEIVE THE FATAL ELECTRIC SHOCK.
- THE EXTERNAL I/O IS NOT CAPABLE OF CONNECTING DIRECTLY TO DEVICES THAT REQUIRE LARGE AMOUNTS OF CURRENT. IN SOME CASES, A CUSTOM INTERFACE CIRCUIT (CUSTOMER PROVIDED) MAY HAVE TO BE USED. SERIOUS DAMAGE TO NETWORK CAMERA MAY RESULT IF A DEVICE IS CONNECTED TO THE EXTERNAL I/O THAT EXCEEDS ITS ELECTRICAL CAPABILITY.

## Appendix B: Troubleshooting & Frequently Asked Questions

Question	Answer or Resolution
<b>Features</b>	
The video and audio codec is adopted in the device.	The device utilizes H.264, MPEG4 and JPEG triple compression to providing high quality images. Where H.264 and MPEG4 are standards for video compression and JPEG is a standard for image compression. The audio codec is defined as AMR for 3GPP and G.711/G.726 for RTSP streaming.
The maximum number of users accesses the device simultaneously.	The maximum number of users is limited to 20. However, it also depends on the total bandwidth accessed to this device from clients. The maximum data throughput of the device is around 20~25Mbps for UDP mode and 10Mbps for HTTP mode. Therefore, the actual number of connected clients is varying by streaming mode, settings of resolution, codec type, frame rate and bandwidth. Obviously, the performance of the each connected client will slow down when many users are logged on.
The device can be used outdoors or not.	The device is not weatherproof. It needs to be equipped with a weatherproof case for outdoors using. However, equipped with a weatherproof case might disable the audio function of the device.
<b>Install this device</b>	
Status LED does not light up.	<ul style="list-style-type: none"> <li>• Check and confirm that the DC power adaptor, included in packaged, is used. Secure the power connector and re-power it on again.</li> <li>• If the problem is not solved, the device might be faulty. Contact your dealer for further help.</li> </ul>
The network cabling is required for the device.	The device uses Category 5 UTP cable allowing 10 and/or 100 Base-T networking.
The device will be installed and work if a firewall exists on the network.	If a firewall exists on the network, port 80 is open for ordinary data communication. The HTTP port and RTSP port need to be opened on the firewall or NAT router.

The username and password for the first time or after factory default reset	Username = <b>admin</b> and Password = <b>airlive</b> . Note that it's all case sensitivity.
Forgot the username and password	Follow the steps below. 1. Restore the factory default setting by press pressing and holding down more than 3 seconds on the device. 2. Reconfigure the device.
Forgot the IP address of the device.	Check IP address of device by using the IPWizard II program or by UPnP discovery.
IPWizard II program cannot find the device.	<ul style="list-style-type: none"> <li>• Re-power the device if cannot find the unit within 1 minutes.</li> <li>• Do not connect device over a router. IPWizard II program cannot detect device over a router.</li> <li>• If IP address is not assigned to the PC which running IPWizard II program, then IPWizard II program cannot find device. Make sure that IP address is assigned to the PC properly.</li> <li>• Antivirus software on the PC might interfere with the setup program. Disable the firewall of the antivirus software during setting up this device.</li> <li>• Check the firewall setting of your PC or Notebook.</li> </ul>
Internet Explorer does not seem to work well with the device	Make sure that your Internet Explorer is version 6.0 or later. If you are experiencing problems, try upgrading to the latest version of Microsoft's Internet Explorer from the Microsoft webpage.
IPWizard II program fails to save the network parameters.	• Network may have trouble. Confirm the parameters and connections of the device.
<b>UPnP NAT Traversal</b>	
Can not work with NAT router	<ul style="list-style-type: none"> <li>• Maybe NAT router does not support UPnP function. Please check user's manual of router and turn on UPnP function.</li> <li>• Maybe UPnP function of NAT router is not compatible to the IP camera. Please contact your dealer to get the approval routers list.</li> </ul>
Some IP cameras are	• Maybe too many IP cameras have been installed on

<p>working but others are failed</p>	<p>the LAN, and then NAT router is out of resource to support more cameras. You could turn off and on NAT router to clear out of date information inside router.</p>
<p><b>Access this device</b></p>	
<p>Cannot access the login page and other web pages of the Network Camera from Internet Explorer</p>	<ul style="list-style-type: none"> <li>• Maybe the IP Address of the Network Camera is already being used by another device or computer. To confirm this possible problem, disconnect the Network Camera from the network first, and then run the PING utility to check it out.</li> <li>• Maybe due to the network cable. Try correcting your network cable and configuration. Test the network interface by connecting a local computer to the Network Camera via a crossover cable.</li> <li>• Make sure the Internet connection and setting is ok.</li> <li>• Make sure enter the IP address of Internet Explorer is correct. If the Network Camera has a dynamic address, it may have changed since you last checked it.</li> <li>• Network congestion may prevent the web page appearing quickly. Wait for a while.</li> </ul> <p>The IP address and Subnet Mask of the PC and Network Camera must be in the same class of the private IP address on the LAN.</p> <ul style="list-style-type: none"> <li>• Make sure the http port used by the Network Camera, default=80, is forward to the Network Camera's private IP address.</li> <li>• The port number assigned in your Network Camera might not be available via Internet. Check your ISP for available port.</li> <li>• The proxy server may prevent you from connecting directly to the Network Camera, set up not to use the proxy server.</li> <li>• Confirm that Default Gateway address is correct.</li> <li>• The router needs Port Forwarding feature. Refer to your router's manual for details.</li> <li>• Packet Filtering of the router may prohibit access from an external network. Refer to your router's manual for details.</li> <li>• Access the Network Camera from the Internet with the</li> </ul>

	<p>global IP address of the router and port number of Network Camera.</p> <ul style="list-style-type: none"> <li>• Some routers reject the global IP address to access the Network Camera on the same LAN. Access with the private IP address and correct port number of Network Camera.</li> <li>• When you use DDNS, you need to set Default Gateway and DNS server address.</li> <li>• If it's not working after above procedure, reset Network Camera to default setting and installed it again.</li> <li>• If the problem is not solved, the Network Camera might be faulty. Contact your dealer for further help.</li> </ul>
Image or video does not appear in the main page.	<ul style="list-style-type: none"> <li>• The first time the PC connects to Network Camera, a pop-up <b>Security Warning window</b> will appear to download ActiveX Controls. When using Windows XP, or Vista, log on with an appropriate account that is authorized to install applications.</li> <li>• Network congestion may prevent the Image screen from appearing quickly. You may choose lower resolution to reduce the required bandwidth.</li> </ul>
Check the device's ActiveX is installed on your computer	<p>Go to C:\Windows\Downloaded Program Files and check to see if there is an entry for the file "<b>IPCamera Control</b>". The status column should show "Installed". If the file is not listed, make sure your Security Settings in Internet Explorer are configured properly and then try reloading the device's home page. Most likely, the ActiveX control did not download and install correctly. Check your Internet Explorer security settings and then close and restart Internet Explorer. Try to browse and log in again.</p>
Internet Explorer displays the following message: "Your current security settings prohibit downloading ActiveX controls".	<p>Setup the IE security settings or configure the individual settings to allow downloading and scripting of ActiveX controls.</p>
The device work	<ul style="list-style-type: none"> <li>• Might be caused from the firewall protection. Check the</li> </ul>

<p>locally but not externally.</p>	<p>Internet firewall with your system or network administrator. The firewall may need to have some settings changed in order for the device to be accessible outside your LAN.</p> <ul style="list-style-type: none"> <li>• Make sure that the device isn't conflicting with any other web server running on your LAN.</li> <li>• Check the configuration of the router settings allow the device to be accessed outside your local LAN.</li> <li>• Check the bandwidth of Internet connection. If the Internet bandwidth is lower than target bit rate, the video streaming will not work correctly.</li> </ul>
<p>The unreadable characters are displayed.</p>	<p>Use the operating system of the selected language. Set the Encoding or the Character Set of the selected language on the Internet Explorer.</p>
<p>Frame rate is slower than the setting.</p>	<ul style="list-style-type: none"> <li>• The traffic of the network and the object of the image affect the frame rate. The network congestion causes frame rate slower than the setting.</li> <li>• Check the bandwidth of Internet connection. If the Internet bandwidth is lower than target bit rate, the video streaming will not work correctly.</li> <li>• Ethernet switching hub can smooth the frame rate.</li> </ul>
<p>Blank screen or very slow video when audio is enabled.</p>	<ul style="list-style-type: none"> <li>• Your connection to the device does not have enough bandwidth to support a higher frame rate for the streamed image size. Try reducing the video streaming size to 160x120 or 320x240 and/or disabling audio.</li> <li>• Audio will consume 32 kbps. Disable audio to improve video. Your Internet connection may not have enough bandwidth to support streaming audio from the device.</li> </ul>
<p>Image Transfer on e-mail or FTP does not work.</p>	<ul style="list-style-type: none"> <li>• Default Gateway and DNS server address should be set up correctly.</li> <li>• If FTP does not work properly, ask your ISP or network administrator about the transferring mode of FTP server.</li> </ul>
<p>Pan/Tilt does not work. (including Click to Center and Preset Positioning)</p>	<ul style="list-style-type: none"> <li>• Click [<b>Refresh</b>] on the Internet Explorer when the communication stops with the device. The image will refresh.</li> <li>• Other clients may be operating Pan/Tilt.</li> <li>• Pan/Tilt operation has reached the end of corner.</li> </ul>
<p>Pan/Tilt does not work</p>	<p>There may be a slight delay when you are using the</p>

smoothly.	Pan/Tilt feature in conjunction with streaming audio and video. If you find that there is a significant delay while panning or tilting the camera, try disabling the audio streaming and/or reducing the video streaming size.
<b>Video quality of the device</b>	
The focus on the Camera is bad.	<ul style="list-style-type: none"> <li>• The lens is dirty or dust is attached. Fingerprints, dust, stain, etc. on the lens can degrade the image quality.</li> </ul>
The color of the image is poor or strange.	<ul style="list-style-type: none"> <li>• Adjust White Balance.</li> <li>• To insure the images you are viewing are the best they can be, set the Display property setting (color quality) to 16bit at least and 24 bit or higher if possible within your computer.</li> <li>• The configuration on the device image display is incorrect. You need to adjust the image related parameters such as brightness, contrast, hue and sharpness properly.</li> </ul>
Image flickers.	<ul style="list-style-type: none"> <li>• Wrong power line frequency makes images flicker. Make sure the 50 or 60Hz format of your device.</li> <li>• If the object is dark, the image will flicker. Make the condition around the Camera brighter.</li> </ul>
Noisy images occur.	The video images might be noisy if the device is located in a very low light environment. Make the condition around the camera brighter or turn the White-light LED on.
<b>Miscellaneous</b>	
Can not play the recorded ASF file	Have installed Microsoft®'s DirectX 9.0 or later and use the Windows Media Player 11.0 or later to play the AVI filed recorded by the Device.

## Appendix C: PING IP Address

The PING (stands for Packet Internet Groper) command is used to detect whether a specific IP address is accessible by sending a packet to the specific address and waiting for a reply. It's also a very useful tool to confirm the device installed or if the IP address conflicts with any other devices over the network.

If you want to make sure the IP address of the device, utilize the PING command as follows:

- Start a DOS window.
- Type ping x.x.x.x, where x.x.x.x is the IP address of the device.

The replies, as illustrated below, will provide an explanation to the problem.

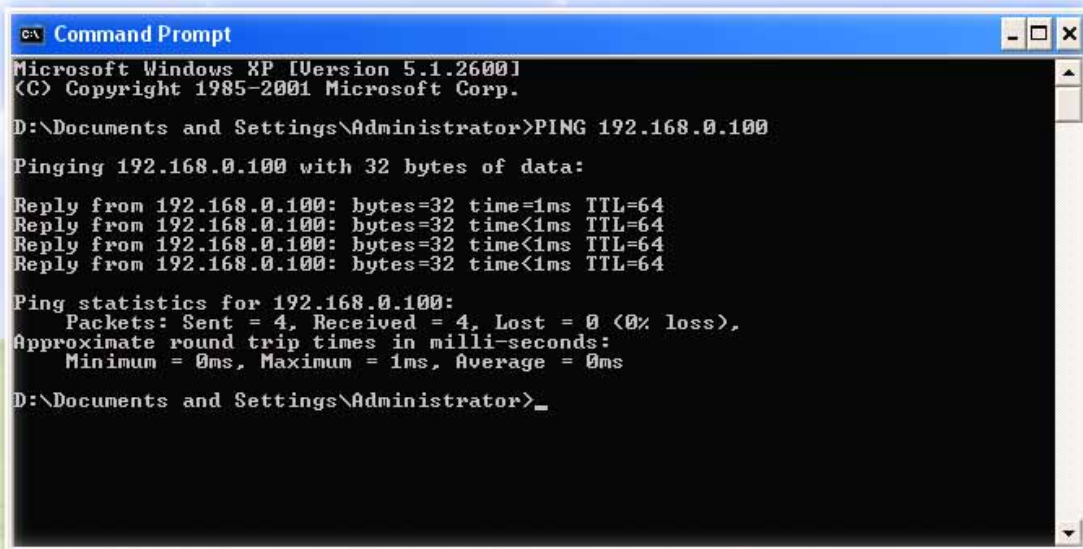

If you want to detect any other devices conflicts with the IP address of Network Camera, also can utilize the PING command but you must disconnect the device from the network first.

## Appendix D: Bandwidth Estimation

The frame rate of video transmitted from the device depends on connection bandwidth between client and server, video resolution, codec type, and quality setting of server. Here is a guideline to help you roughly estimate the bandwidth requirements form your device.

The required bandwidth depends on content of video source. The slow motion video will produce smaller bit rate generally and fast motion will produce higher bit rate vice versa. Actual results generated by the device may be varying.

Image Resolution	Average range of data sizes for JPEG mode	Average bit rate for MPEG4 mode	Average bit rate for H.264 mode
160 x 120	3 ~ 6k byte per	64kbps~256kbps	32kbps~192kbps

(QQVGA)	frame	@ 30fps	@ 30fps
320 x 240 (QVGA)	8 ~ 20k byte per frame	256kbps~768kbps @ 30fps	192kbps~512kbps @ 30fps
640 x 480 (VGA)	20 ~ 50K byte per frame	512kbps~2048kbps @ 30fps	384kbps~1536kbps @ 30fps
1280x1024 (SXGA)	100 ~ 200k byte per frame	NA	512kbps~3076kbps @ 15fps

**Note:** Audio streaming also takes bandwidth around 32kbps. Some xDSL/Cable modem upload speeds could not even reach up to 128 kbps. Thus, you may not be able to receive good quality video while also streaming audio on a 128 kbps or lower connection. Even though the upload speed is more than 128kbps, for optimal video performance, disabling audio streaming will get better video performance.

## Appendix E: Specifications

Camera	
<b>Model Name</b>	OD-2025HD/ OD-2025PHD
<b>Image Device</b>	2 Mega-pixel image sensor
<b>Effective Pixels</b>	1920 x 1080 pixels
<b>Lens</b>	4.2mm
IP Module	
Video	
<b>Video Encoder</b>	H.264, MPEG4 and Motion JPEG simultaneously
<b>Video Profile</b>	Up to 20 profiles simultaneously
<b>Frame Rate</b>	Up to 30fps for all resolutions
<b>Image Setting</b>	AE, AWB 3D Noise reduction Color, brightness, sharpness, contrast, Hue Mirror/Flip Privacy Masks Text, time and date overlay
<b>Streaming</b>	Simultaneously multi-profile streaming Streaming over UDP, TCP, or HTTP M-JPEG streaming over HTTP (server push) Supports 3GPP mobile surveillance (MPEG4) Controllable frame rate and bandwidth Constant and variable bit rate (MPEG4 / H.264) ROI
Audio	
<b>Audio Encoder</b>	RTSP: G.711 64kbps, G.726 32kbps 3GPP: AMR
<b>Audio Streaming</b>	One-way or two-way

<b>Microphone</b>	External microphone input
<b>Audio Output</b>	Adjustable audio output gain
<b>Network</b>	
<b>Supported Protocols</b>	IPv4, TCP, UDP, HTTP, HTTPS, SMTP, FTP, NTP, DNS, DDNS, DHCP, DIPS, ARP, Bonjour, UPnP, RTSP, RTP, RTCP, IGMP, PPPoE, 3GPP, Samba, ICMP
<b>Security</b>	Password protection, IP address filtering, HTTPS encrypted data transmission, user access log
<b>Users</b>	20 simultaneous users (unicast)
<b>Ethernet</b>	10/100M auto negotiation
<b>System Integration</b>	
<b>Application Programming Interface</b>	ONVIF Open API for software integration SDK
<b>Alarm Triggers</b>	Intelligent video motion detection and external input
<b>Motion Detection</b>	Up to 10 motion detection areas with included or excluded options
<b>Alarm Events</b>	File upload via FTP or email Notification via email, HTTP, and TCP External output activation Audio alerting output
<b>Video Buffer</b>	Pre- and post- alarm buffering
<b>General</b>	
<b>RAM</b>	256MB
<b>ROM</b>	16MB
<b>Power Supply</b>	12V DC external power adapter
<b>PoE</b>	OD-2025HD: IEEE 802.3af OD-2025PHD 12V Passive POE
<b>Power Consumption</b>	8W (Max)
<b>Connectors</b>	RJ-45 10BaseT/100BaseTX DC power jack 1 alarm input and 1 output RS485 External MIC input Audio out Factory default reset
<b>Indication LED</b>	Green and orange LEDs
<b>Illumination LED</b>	24 IR LEDs
<b>Operating Temperature</b>	-10°C to 50°C (32°F to 104°F)
<b>Operating Humidity</b>	20% ~ 80% (non-condensing)
<b>Dimension</b>	HxWxD: 97x86x81 mm
<b>Viewing System</b>	
<b>OS</b>	Windows® XP, Vista, 7
<b>Browser</b>	IE 6.0 or later, Firefox 2.0 or later, Safari
<b>Cell Phone</b>	With 3GPP player
<b>Video Player</b>	VLC, Quick Time, Real Player, Core Player
<b>Software</b>	
<b>Search &amp; Installation</b>	IPWizard II
<b>Bundled NVR Program</b>	CamPro Express 64, CamPro HD

## Appendix F: Configure Port Forwarding Manually

The device can be used with a router. If the device wants to be accessed from the WAN, its IP address needs to be setup as fixed IP address, also the port forwarding or Virtual Server function of router needs to be setup. This device supports UPnP traversal function. Therefore, user could use this feature to configure port forwarding of NAT router first. However, if user needs to configure port forwarding manually, please follow the steps as below:

Manually installing the device with a router on your network is an easy 3–step procedure as following:

- (1) Assign a local/fixed IP address to your device
- (2) Access the Router with Your Web browser
- (3) Open/Configure Virtual Server Ports of Your Router

### (1) Assign a local/fixed IP address to your device

The device must be assigned a local and fixed IP Address that allows it to be recognized by the router. Manually setup the device with a fixed IP address, for example, 192.168.0.100.

### (2) Access the Router with Your Web browser

The following steps generally apply to any router that you have on your network. The D-Link DI-624 is used as an example to clarify the configuration process. Configure the initial settings of the router by following the steps outlined in the router's **Quick Installation Guide**.

If you have cable or DSL service, you will most likely have a dynamically assigned WAN IP Address. 'Dynamic' means that your router's WAN IP address can change from time to time depending on your ISP. A dynamic WAN IP Address identifies your router on the public network and allows it to access the Internet. To find out what your router's WAN IP Address is, go to the **Status** screen on your router and locate the WAN information for your router. As shown on the following page the WAN IP Address will be listed. This will be the address that you will need to type in your web browser to view your camera over the Internet. Be sure to uncheck the **Reset IP address at next boot** button at the top of the screen after modifying the IP address. Failure to do so will reset the IP address when you restart your computer.

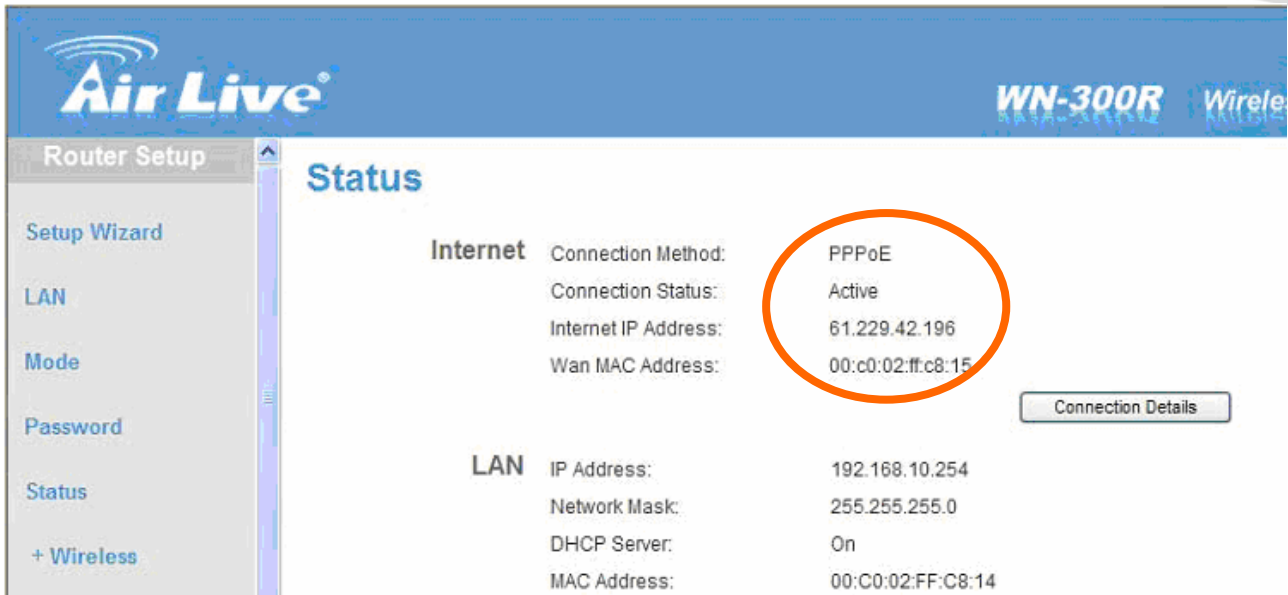

Your WAN IP Address will be listed here.

**Note:** Because a dynamic WAN IP can change from time to time depending on your ISP, you may want to obtain a Static IP address from your ISP. A Static IP address is a fixed IP address that will not change over time and will be more convenient for you to use to access your camera from a remote location. If you could not get a Static IP address from your ISP, the DIPS™ or DDNS is a solution alternatively. Please refer to Appendix G for more information.

### (3) Open/set Virtual Server Ports to enable remote image viewing

The firewall security features built into the router and most routers prevent users from accessing the video from the device over the Internet. The router connects to the Internet over a series of numbered ports. The ports normally used by the device are blocked from access over the Internet. Therefore, these ports need to be made accessible over the Internet. This is accomplished using the Virtual Server function on the router. The **Virtual Server** ports used by the camera must be opened through the router for remote access to your camera. Virtual Server is accessed by clicking on the **Advanced** tab of the router screen.

Follow these steps to configure your router's Virtual Server settings

- Click **Enabled**.
- Enter a unique name for each entry.
- Select **Both** under **Protocol Type (TCP and UDP)**

- Enter your camera's local IP Address (e.g., **192.168.0.100**, for example) in the **Private IP** field.
- If you are using the default camera port settings, enter **80** into the **Public** and **Private Port** section, click **Apply**.
- **Scheduling** should be set to **Always** so that the camera images can be accessed at any time.

A check mark appearing before the entry name will indicate that the ports are enabled.

**Important:** Some ISPs block access to port 80. Be sure to check with your ISP so that you can open the appropriate ports accordingly. If your ISP does not pass traffic on port 80, you will need to change the port the camera uses from 80 to something else, such as 8080. Not all routers are the same, so refer to your user manual for specific instructions on how to open ports.

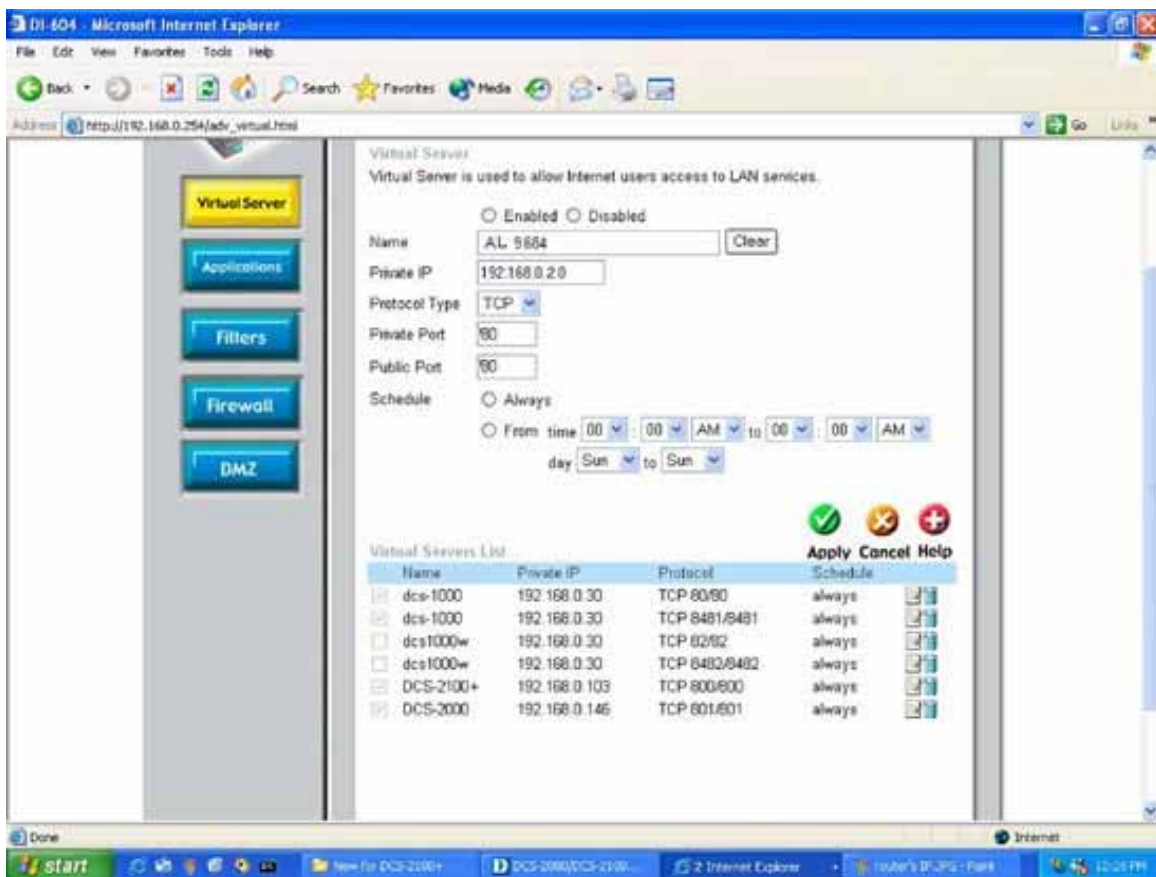

Enter valid ports in the **Virtual Server** section of your router. Please make sure to check the box on this line to enable settings. Then the device can be access from WAN by the router's WAN IP Address.

By now, you have finished your entire PC configuration for this device.

## Appendix G: DDNS Application

- **Preface**

If you have a Cable modem or xDSL, this is a great way to host your own Networked Device or other TCP/IP Service. Get your own domain like www.yourname.com, www.yourname.com.tw etc. (Note: This domain must be registered with Internic via registration authorities such as Network Solutions, DirectNIC, Register.com etc). Your domain name's dynamic IP address is automatically tracked by a DDNS server. Host your own Networked Device and much more no matter what your computer's IP address may be and even if you have dialup, DSL or cable modem internet connection where your computer's IP address changes all the time!! DDNS service supports all top level domain names including but not limited to .com, .net, .org, .to, .uk etc.

- **Ethernet Network Environment**

Normally, DDNS service is only necessary for the users that could only obtain dynamic IP addresses. As to the users that could obtain the static valid IP address, they do not usually have to apply the DDNS service. Before we decide if DDNS is necessary for the users, we have to check what kind of Ethernet network environment we have to install our Networked Device on.

(1) Environment of Fixed Valid IP Network

If users could obtain valid IP addresses, they could save the effort to apply DDNS service. Because the IP address in this environment is fixed, users could input the IP address or domain name of demo site directly in the IE browser.

(2) Environment of Dynamic IP Network

If users is under an environment of dynamic IP network (Dial-up xDSL), they have to apply a domain name in advance. Then apply DDNS service. Finally setup the necessary information of DDNS and PPPoE of the Networked Device in order to let the outside administrator be able to access through internet.

- **Application Steps—DDNS & Domain Name**

- (1). Visit the following web site: <http://www.dyndns.org/>
- (2). Click "**Account**"

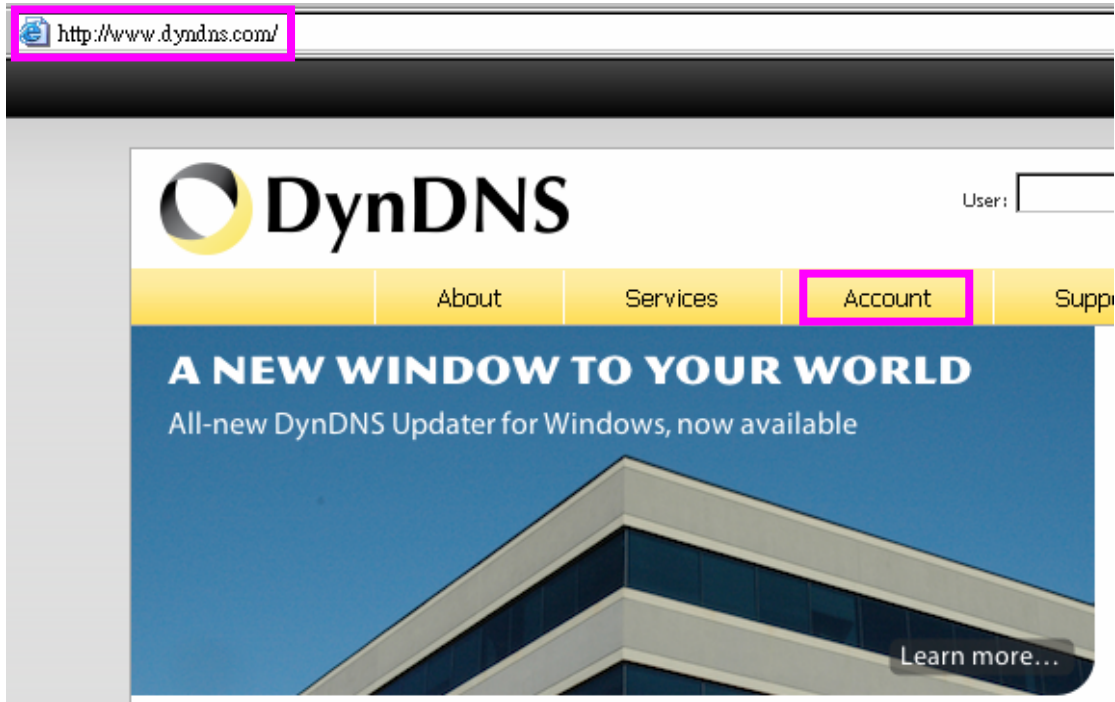

(3). After the columns show up at the left side, click **“Create Account”**.



(4). Fill the application agreement and necessary information.

- a. Username
- b. E-mail address and confirmation
- c. Password and confirmation
- d. Submit all the input information and finish creating an account

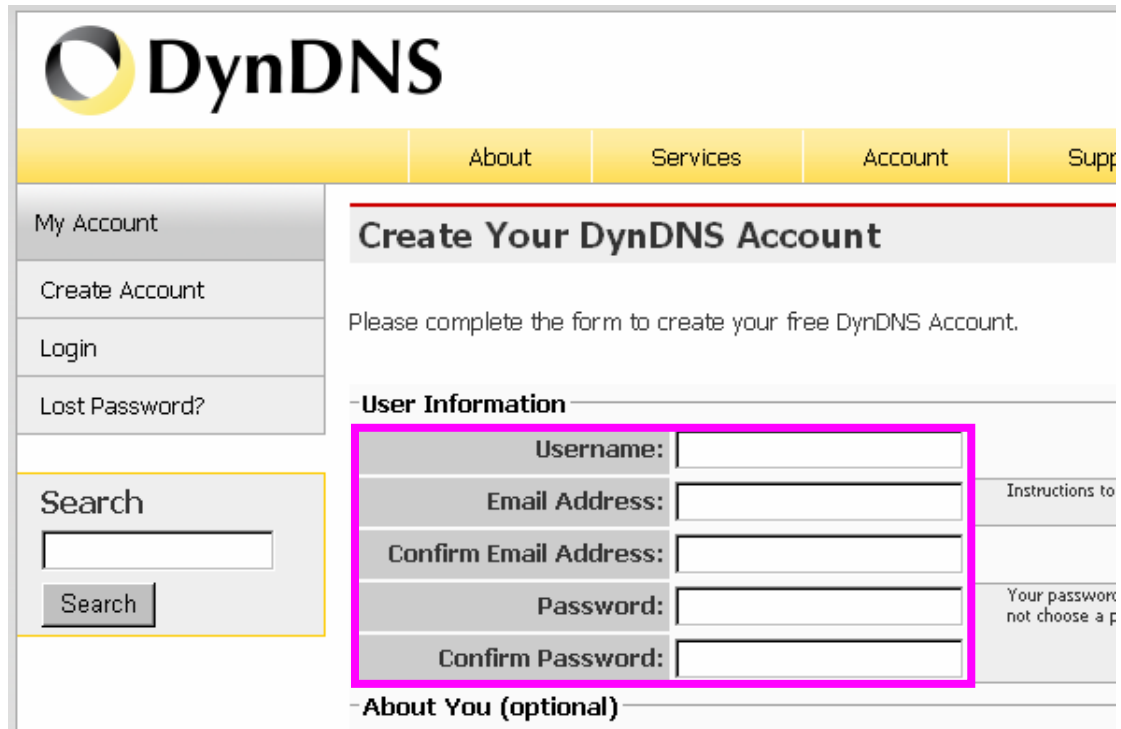

#### Terms of Service

Please read the acceptable use policy (AUP) and accept it prior to creating your account. Also acknowledge that you may only have one (1) free account, and that creation of multiple free accounts will result in the deletion of all of your accounts.

' and 'I will only create one (1) free account: '. A pink box highlights these two checkboxes, and a pink arrow points to them with the text 'Click these two options'." data-bbox="135 538 640 757"/>

#### Next Step

After you click "Create Account", we will create your account and send you an e-mail to the address you provided. Please follow the instructions in that e-mail to confirm your account. You will need to confirm your account within 48 hours or we will automatically delete your account. (This helps prevent unwanted robots on our systems)

(5). Check your e-mail mailbox. There will be an e-mail with a title “Your DynDNS Account Information“. Click the hyperlink address to confirm the DDNS service that you just applied. Then DDNS you applied activated.

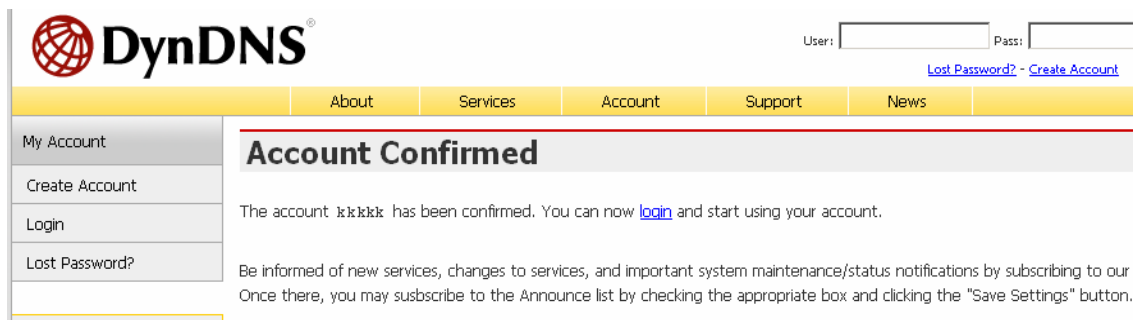
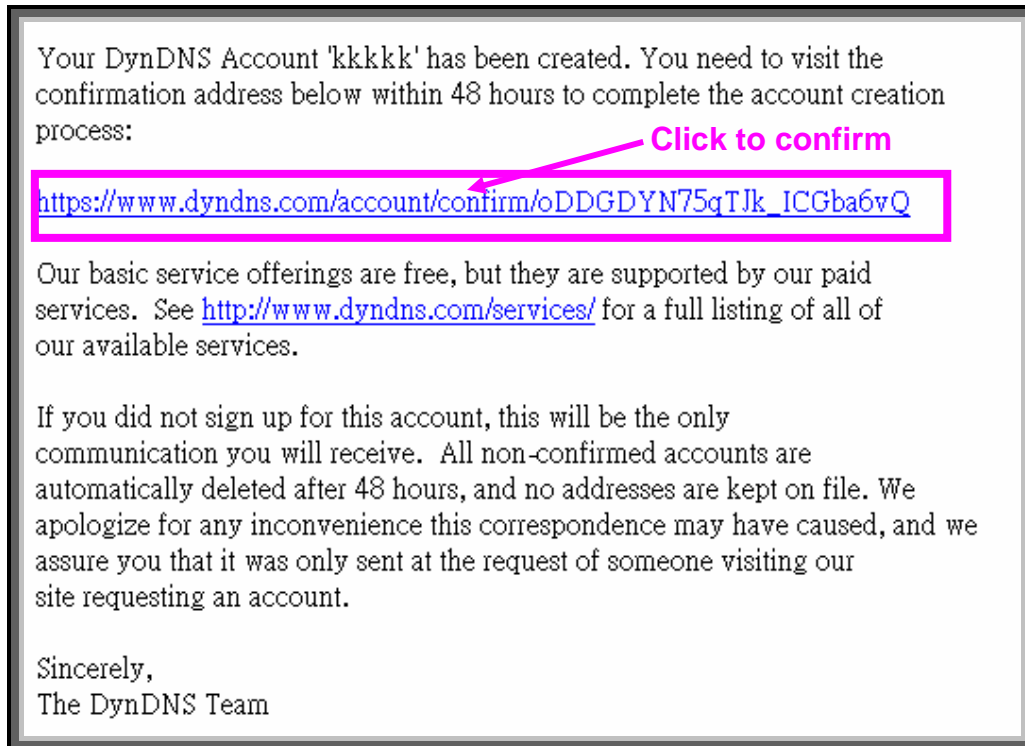

(6). Enter the web page <http://www.dyndns.org/> again. Input your username and password that you just applied to login administration interface of DDNS server.

Input your account

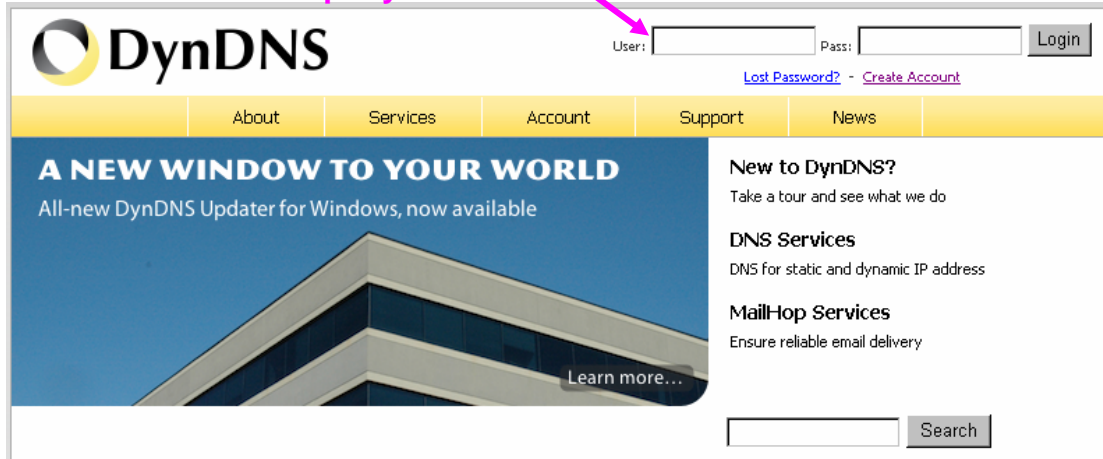

(7). If the correct username and password are input, you can see the following picture at the top-right of the login page.

(8). Click the “[Services](#)”.

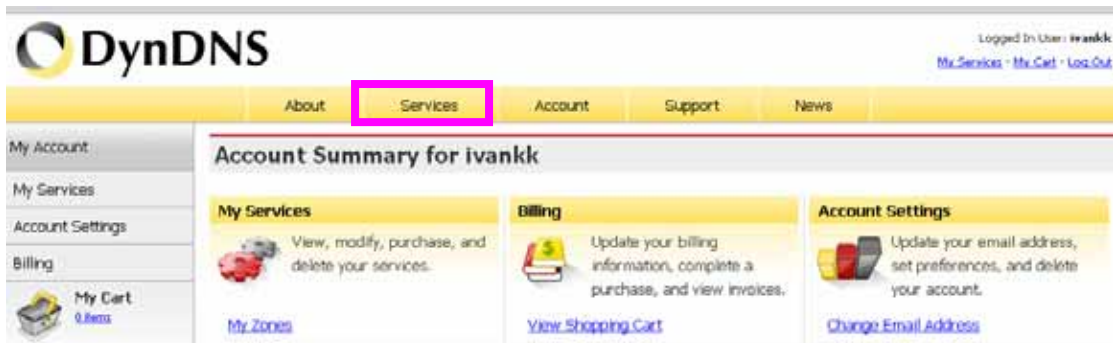

(9). Click the “Dynamic DNS”.

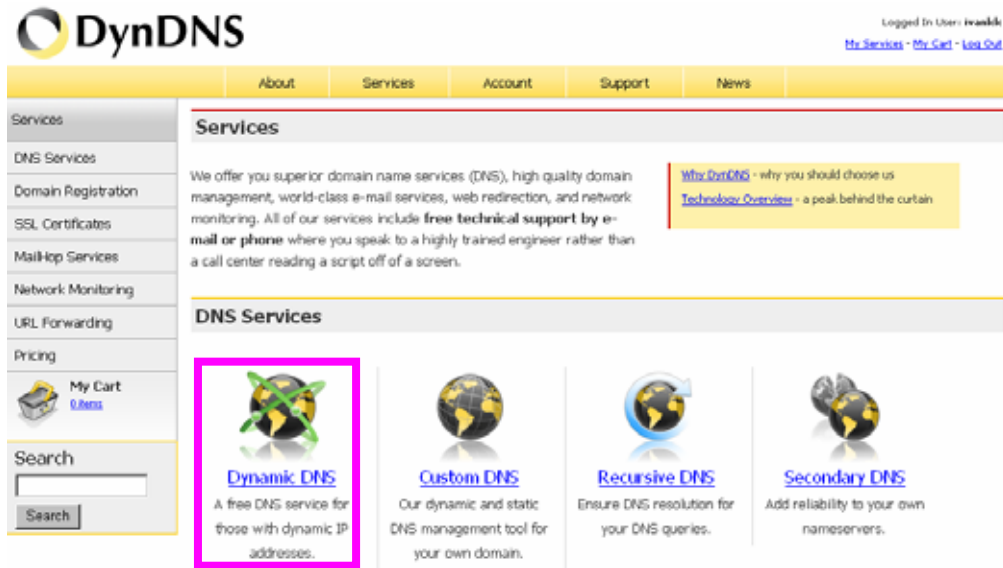

(10). Click the “Get Started”.

## Dynamic DNS

Dynamic DNS (DDNS) allows you to create a hostname that points to your dynamic IP or static IP address or URL. We also provide an update mechanism which makes the hostname work with your dynamic IP address. **We continue to offer this service free** to the Internet community as we have done so **for nearly 10 years**.

### Capabilities and Features

- Get five (5) hostnames in [88 available domains](#) for free.
- Create wildcard CNAME *\*.yourhost.dyndns.org* for *yourhost.dyndns.org*.
- Forward web requests or mark host offline for maintenance or downtime.
- Configure MX records for flexible mail routing.
- Update host using [ddns update clients](#) for a wide variety of platforms.
- Modify DNS TTL values for fast propagation or reliable static IP caching.
- Deliver your DNS records to 5 DNS servers in 5 tier-1 datacenters around the globe.
- Query volume up to 648,000 queries/month

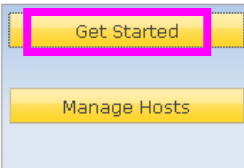

Our **free industry-leading e-mail support** is ready to help you setup your dynamic or static DNS so you can host a website, remotely connect to your machine, and run a mail server. We also offer other premium features with our [Account Upgrade](#) service.

(11). We could create a domain name without any charge at this step. First, we input the host name. (Pink No.1) Then we pick a domain that is easy to remember. (Pink No.2) The 3rd step is to click “Offline Hostname” from Service Type. (Pink No.3) Finally, click the “Create Host” to submit the domain name information and finish DDNS application. (Pink No.4)

### Add New Hostname

[↑ Host Services](#)

Note: You currently don't have Account Upgrades in your account. You cannot use some of our Host Service features. Please consider buying Account upgrade that make this form full-functional and will add several other features. [Learn More...](#)

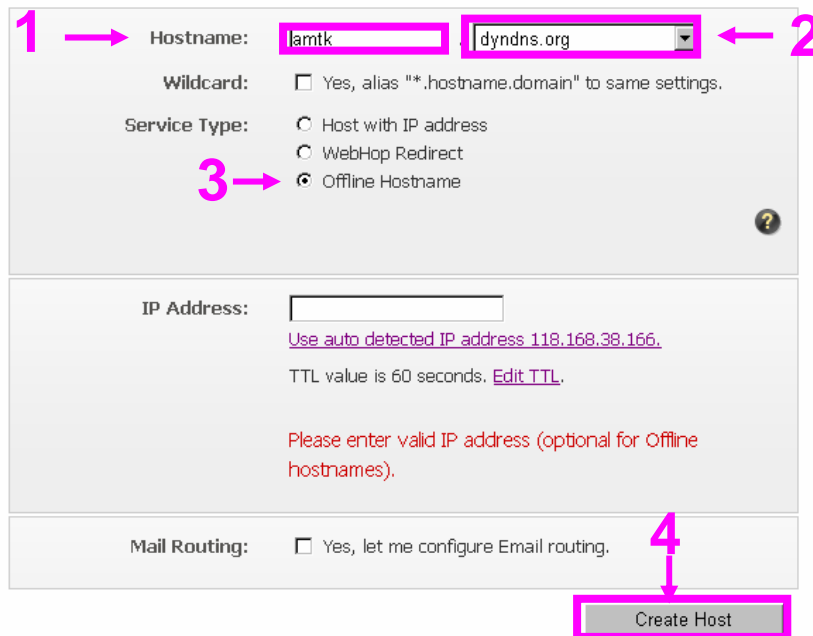

1 → Hostname:  .  ← 2

Wildcard:  Yes, alias "\*" .hostname.domain" to same settings.

Service Type:

- Host with IP address
- WebHop Redirect
- Offline Hostname

3 →

IP Address:

[Use auto detected IP address 118.168.38.166.](#)

TTL value is 60 seconds. [Edit TTL.](#)

Please enter valid IP address (optional for Offline hostnames).

Mail Routing:  Yes, let me configure Email routing.

4 ↓

- **Setup the DDNS and PPPoE of Networked Device**

At last, users have to enter the web page of Networked Device and setup the necessary information of DDNS and PPPoE after the application of DDNS service. Please check the user manual to access the DDNS and PPPoE pages. After saving the modification, restart the device. Then the external users could browse the Networked Device by the input of their domain name.

## Appendix H: Power Line Frequency

COUNTRY	VOLTAGE	FREQUENCY	COMMENTS
Argentina	220V	50 Hz	*Neutral and line wires are reversed from that used in Australia and elsewhere.
Australia	230V*	50 Hz	*Outlets typically controlled by adjacent switch. Though nominal voltage has been

			officially changed to 230V, 240V is within tolerances and commonly found.
Austria	230V	50 Hz	
Brazil	110/220V*	60 Hz	*127V found in states of Bahia, Paran?(including Curitiba), Rio de Janeiro, S 綫 Paulo and Minas Gerais (though 220V may be found in some hotels). Other areas are 220V only, with the exception of Fortaleza (240V).
Canada	120V	60 Hz	
China, People's Republic of	220V	50 Hz	
Finland	230V	50 Hz	
France	230V	50 Hz	
Germany	230V	50 Hz	
Hong Kong	220V*	50 Hz	
India	230V	50 Hz	
Italy	230V	50 Hz	
Japan	100V	50/60 Hz*	*Eastern Japan 50 Hz (Tokyo, Kawasaki, Sapporo, Yokohoma, and Sendai); Western Japan 60 Hz (Osaka, Kyoto, Nagoya, Hiroshima)
Malaysia	240V	50 Hz	
Netherlands	230V	50 Hz	
Portugal	230V	50 Hz	
Spain	230V	50 Hz	
Sweden	230V	50 Hz	
Switzerland	230V	50 Hz	
Taiwan	110V	60 Hz	
Thailand	220V	50 Hz	

United Kingdom	230V*	50 Hz	*Outlets typically controlled by adjacent switch. Though nominal voltage has been officially changed to 230V, 240V is within tolerances and commonly found.
United States of America	120V	60 Hz	

## Appendix I: 3GPP

To use the 3GPP function, in addition to previous section, you might need more information or configuration to make this function work.

**Note** that to use the 3GPP function, it strongly recommends to install the Networked Device with a public and fixed IP address without any firewall protection.

### RTSP Port:

Port 554 is the default for RTSP service. However, sometimes, some service providers change this port number for some reasons. If so, user needs to change this port accordingly.

### Dialing procedure:

1. Choose a verified player (PacketVideo or Realplayer currently)
2. Use the following URL to access:  
rtsp://host/mpeg4/media.3gp

Where host is the host name or IP address of the camera.

### Compatible 3G mobile phone:

Please contact your dealer to get the approved list of compatible 3G phone.

## Appendix J: Enable UPnP of Windows XP

Use the following steps to enable UPnP settings only if your operating system of PC is running Windows XP.

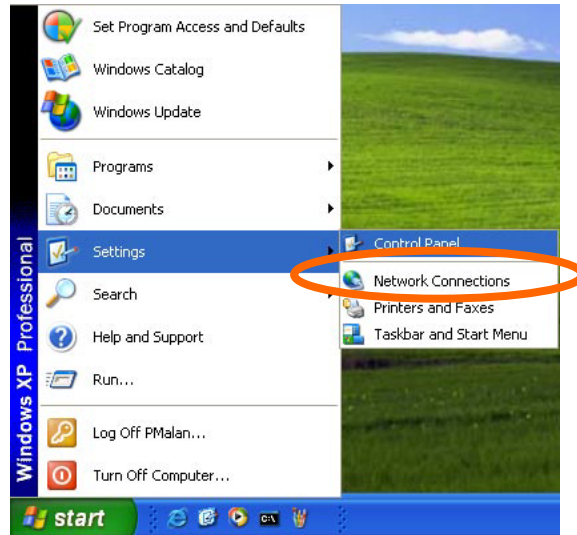

Go to **Start > Settings**.  
Click Control Panel

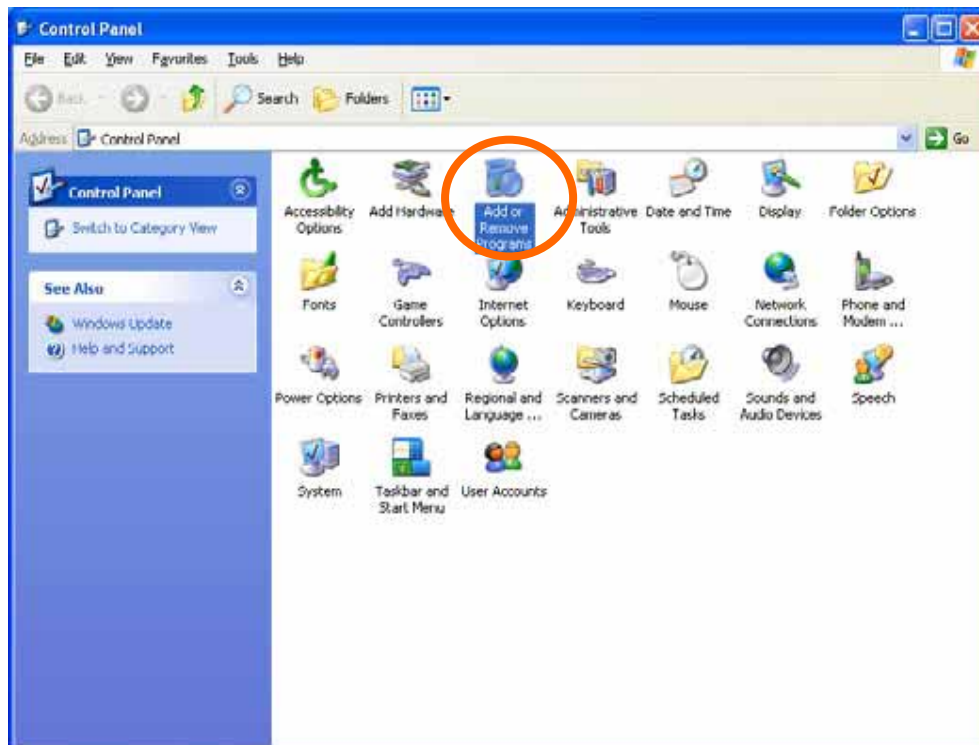

Click Add or Remove Programs

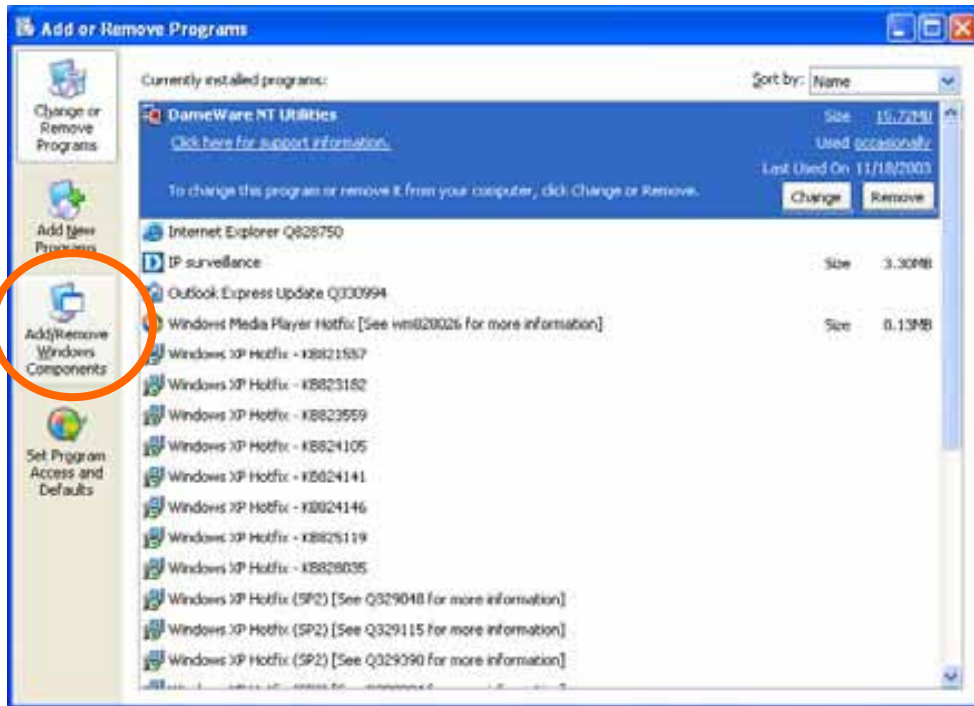

Click Add/Remove Windows Components

The following screen will appear:

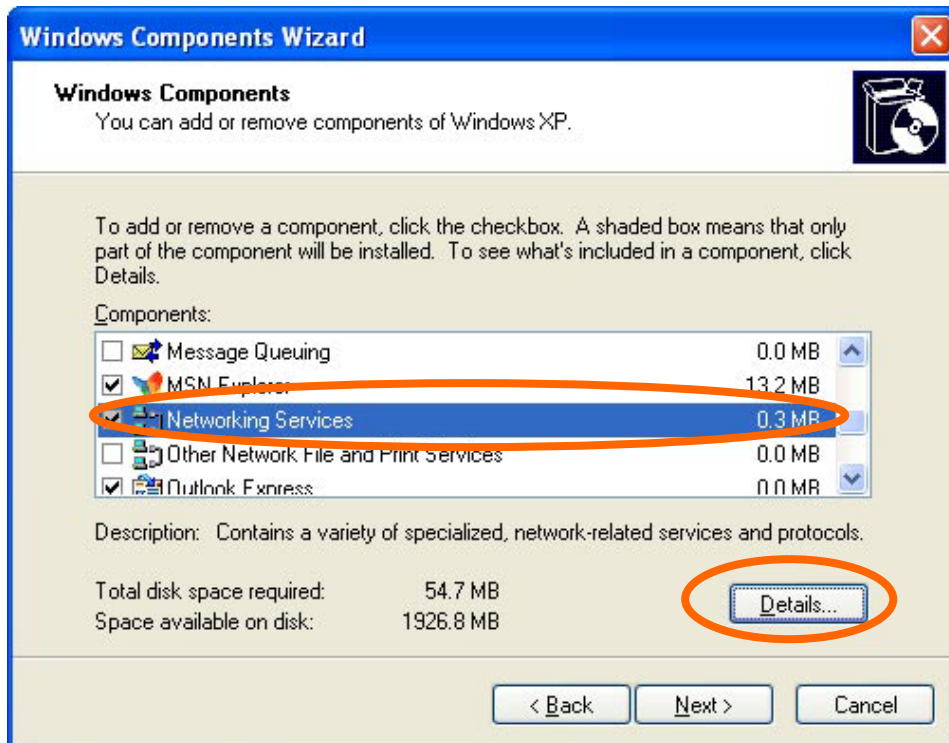

Select Networking Services

Click Details

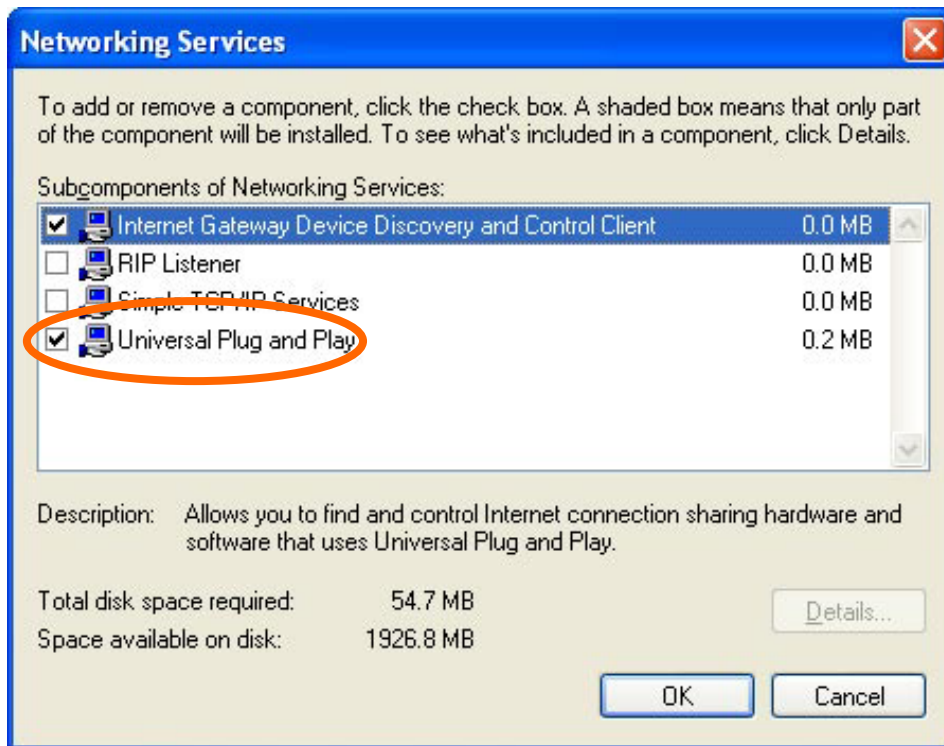

Select Universal Plug and Play  
Click Ok

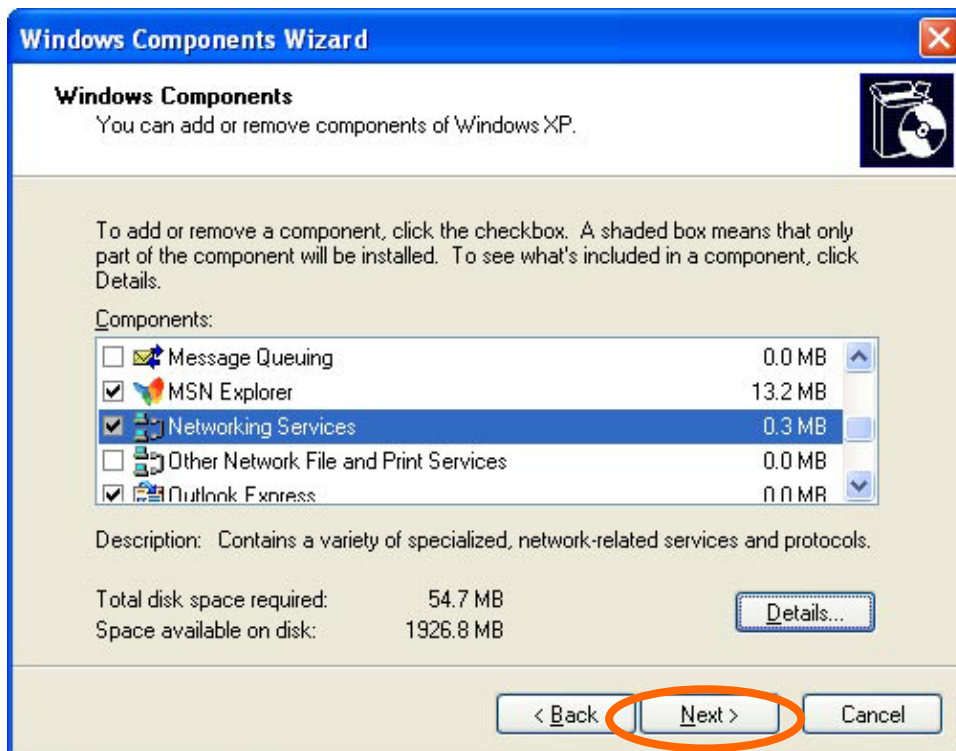

Click Next

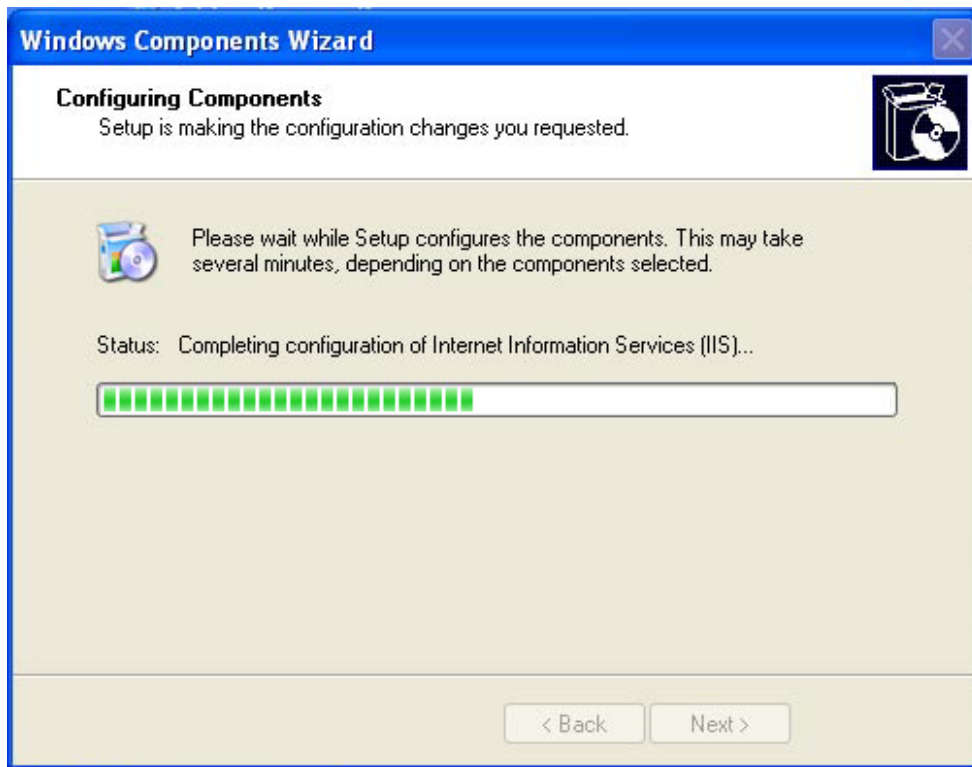

Please wait while Setup configures the components.



Click Finish