



WL-1600GL
802.11g Wireless
Broadband Router
User's Manual



www.airlive.com

COPYRIGHT

Copyright ©2005/2006 by this company. All rights reserved. No part of this publication may be reproduced, transmitted, transcribed, stored in a retrieval system, or translated into any language or computer language, in any form or by any means, electronic, mechanical, magnetic, optical, chemical, manual or otherwise, without the prior written permission of this company

This company makes no representations or warranties, either expressed or implied, with respect to the contents hereof and specifically disclaims any warranties, merchantability or fitness for any particular purpose. Any software described in this manual is sold or licensed "as is". Should the programs prove defective following their purchase, the buyer (and not this company, its distributor, or its dealer) assumes the entire cost of all necessary servicing, repair, and any incidental or consequential damages resulting from any defect in the software. Further, this company reserves the right to revise this publication and to make changes from time to time in the contents hereof without obligation to notify any person of such revision or changes.

All brand and product names mentioned in this manual are trademarks and/or registered trademarks of their respective holders.

Federal Communication Commission Interference Statement

This equipment has been tested and found to comply with the limits for a Class B digital device, pursuant to Part 15 of FCC Rules. These limits are designed to provide reasonable protection against harmful interference in a residential installation. This equipment generates, uses, and can radiate radio frequency energy and, if not installed and used in accordance with the instructions, may cause harmful interference to radio communications. However, there is no guarantee that interference will not occur in a particular installation. If this equipment does cause harmful interference to radio or television reception, which can be determined by turning the equipment off and on, the user is encouraged to try to correct the interference by one or more of the following measures:

1. Reorient or relocate the receiving antenna.
2. Increase the separation between the equipment and receiver.
3. Connect the equipment into an outlet on a circuit different from that to which the receiver is connected.
4. Consult the dealer or an experienced radio technician for help.

FCC Caution

This equipment must be installed and operated in accordance with provided instructions and a minimum 20 cm spacing must be provided between computer mounted antenna and person's body (excluding extremities of hands, wrist and feet) during wireless modes of operation.

This device complies with Part 15 of the FCC Rules. Operation is subject to the following two conditions: (1) this device may not cause harmful interference, and (2) this device must accept any interference received, including interference that may cause undesired operation.

Any changes or modifications not expressly approved by the party responsible for compliance could void the authority to operate equipment.

Federal Communication Commission (FCC) Radiation Exposure Statement

This equipment complies with FCC radiation exposure set forth for an uncontrolled environment. In order to avoid the possibility of exceeding the FCC radio frequency exposure limits, human proximity to the antenna shall not be less than 20cm (8 inches) during normal operation.

The antenna(s) used for this transmitter must not be co-located or operating in conjunction with any other antenna or transmitter.

R&TTE Compliance Statement

This equipment complies with all the requirements of DIRECTIVE 1999/5/EC OF THE EUROPEAN PARLIAMENT AND THE COUNCIL of March 9, 1999 on radio equipment and telecommunication terminal Equipment and the mutual recognition of their conformity (R&TTE)

The R&TTE Directive repeals and replaces in the directive 98/13/EEC (Telecommunications Terminal Equipment and Satellite Earth Station Equipment) As of April 8, 2000.

Safety

This equipment is designed with the utmost care for the safety of those who install and use it. However, special attention must be paid to the dangers of electric shock and static electricity when working with electrical equipment. All guidelines of this

and of the computer manufacture must therefore be allowed at all times to ensure the safe use of the equipment.

EU Countries Intended for Use

The ETSI version of this device is intended for home and office use in Austria, Belgium, Denmark, Finland, France, Germany, Greece, Ireland, Italy, Luxembourg, the Netherlands, Portugal, Spain, Sweden, and the United Kingdom.

The ETSI version of this device is also authorized for use in EFTA member states: Iceland, Liechtenstein, Norway, and Switzerland.

EU Countries Not intended for use

None.

Table of Contents

CHAPTER 1 INTRODUCTION	1
Wireless Router Features	1
Package Contents	4
Physical Details	5
CHAPTER 2 INSTALLATION.....	7
Requirements.....	7
Procedure	7
CHAPTER 3 SETUP	9
Overview	9
Configuration Program	11
Setup Wizard	13
LAN Screen.....	16
Wireless Screen.....	18
Password Screen.....	24
CHAPTER 4 PC CONFIGURATION	25
Overview	25
Windows Clients.....	25
Macintosh Clients.....	37
Linux Clients.....	37
Other Unix Systems.....	37
Wireless Station Configuration.....	38
CHAPTER 5 OPERATION AND STATUS.....	39
Operation	39
Status Screen.....	39
Connection Status - PPPoE	41
Connection Status - PPTP	44
Connection Status - L2TP.....	46
Connection Status - Telstra Big Pond.....	49
Connection Details - SingTel RAS	50
Connection Details - Fixed/Dynamic IP Address	52
CHAPTER 6 ADVANCED FEATURES	54
Overview	54
Access Control.....	54
Dynamic DNS (Domain Name Server)	60
Advanced Internet Screen	62
URL Filter.....	67
Define Schedule	69
User Groups.....	70
Virtual Servers.....	72
WAN Port Configuration	77
CHAPTER 7 ADVANCED ADMINISTRATION.....	81
Overview	81
Config File.....	82
Logs.....	83
Network Diagnostics	85
Options	87
PC Database.....	89

Remote Admin	93
Routing	95
Security	100
Upgrade Firmware	102
APPENDIX A TROUBLESHOOTING	103
Overview	103
General Problems	103
Internet Access	103
Wireless Access	104
APPENDIX B ABOUT WIRELESS LANS	105
Modes	105
BSS/ESS	105
Channels	106
WEP	106
WPA-PSK	106
WPA2-PSK	107
Wireless LAN Configuration	107
APPENDIX C SPECIFICATIONS	108
Multi-Function Wireless Router	108
Wireless Interface	108
Regulatory Approvals	109

Copyright © 2008. All Rights Reserved.

Document Version: 1.0

All trademarks and trade names are the properties of their respective owners.

Chapter 1

1

Introduction

This Chapter provides an overview of the Wireless Router's features and capabilities.

Congratulations on the purchase of your new Wireless Router. The Wireless Router is a multi-function device providing the following services:

- **Shared Broadband Internet Access** for all LAN users.
- **4-Port Switching Hub** for 10BaseT or 100BaseT connections.
- **Wireless Access Point** for 802.11b and 802.11g Wireless Stations.

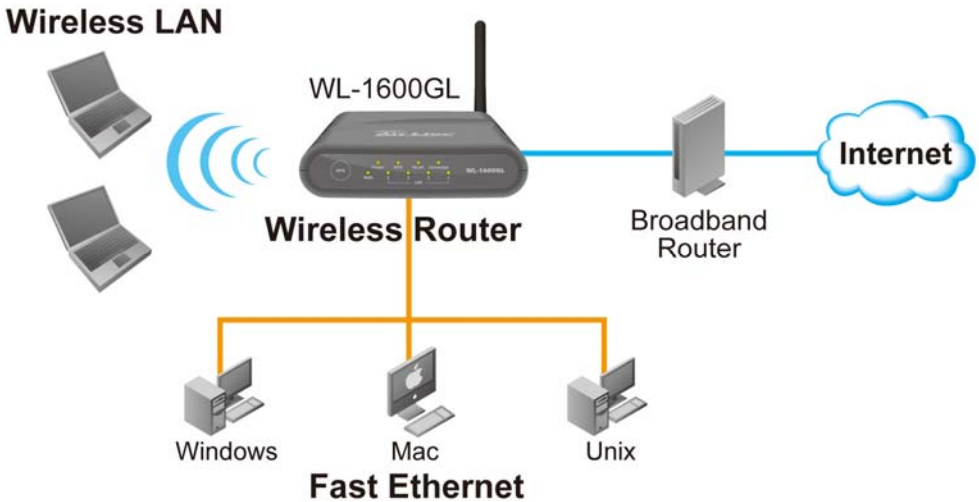

Figure 1: Wireless Router

Wireless Router Features

The Wireless Router incorporates many advanced features, carefully designed to provide sophisticated functions while being easy to use.

Internet Access Features

- **Shared Internet Access.** All users on the LAN or WLAN can access the Internet through the Wireless Router, using only a single external IP Address. The local (invalid) IP Addresses are hidden from external sources. This process is called NAT (Network Address Translation).
- **DSL & Cable Modem Support.** The Wireless Router has a 10/100BaseT Ethernet port for connecting a DSL or Cable Modem. All popular DSL and Cable Modems are supported. SingTel RAS and Big Pond (Australia) login support is also included.
- **PPPoE, PPTP, SingTel RAS and Telstra Big Pond Support.** The Internet (WAN port) connection supports PPPoE (PPP over Ethernet), PPTP (Peer-to-Peer Tunneling Protocol), SingTel RAS and Telstra Big Pond (Australia), as well as "Direct Connection" type services. Unnumbered IP with PPPoE is also supported.

- **Fixed or Dynamic IP Address.** On the Internet (WAN port) connection, the Wireless Router supports both Dynamic IP Address (IP Address is allocated on connection) and Fixed IP Address.

Advanced Internet Functions

- **Communication Applications.** Support for Internet communication applications, such as interactive Games, Telephony, and Conferencing applications, which are often difficult to use when behind a Firewall, is included.
- **Special Internet Applications.** Applications which use non-standard connections or port numbers are normally blocked by the Firewall. The ability to define and allow such applications is provided, to enable such applications to be used normally.
- **Virtual Servers.** This feature allows Internet users to access Internet servers on your LAN. The required setup is quick and easy.
- **DDNS Support.** DDNS (Dynamic DNS) allows Internet users to connect to Virtual Servers on your LAN using a domain name, even if your IP address is not fixed.
- **Multi-DMZ.** For each WAN (Internet) IP address allocated to you, one (1) PC on your local LAN can be configured to allow unrestricted 2-way communication with Servers or individual users on the Internet. This provides the ability to run programs which are incompatible with Firewalls.
- **URL Filter.** Use the URL Filter to block access to undesirable Web sites by LAN users.
- **Internet Access Log.** See which Internet connections have been made.
- **Access Control.** Using the Access Control feature, you can assign LAN users to different groups, and determine which Internet services are available to each group.
- **VPN Pass through Support.** PCs with VPN (Virtual Private Networking) software using PPTP, L2TP and IPSec are transparently supported - no configuration is required.

Wireless Features

- **Standards Compliant.** The Wireless Router complies with the IEEE802.11g (DSSS) specifications for Wireless LANs.
- **Supports both 802.11b and 802.11g Wireless Stations.** The 802.11g standard provides for backward compatibility with the 802.11b standard, so both 802.11b and 802.11g Wireless stations can be used simultaneously.
- **Speeds to 54Mbps.** All speeds up to the 802.11g maximum of 54Mbps are supported.
- **WEP support.** Support for WEP (Wired Equivalent Privacy) is included. Key sizes of 64 Bit and 128 Bit are supported.
- **WPA support.** Support for WPA is included. WPA is more secure than WEP, and should be used if possible.
- **WPA2 support.** Support for WPA2 is also included. WPA2 uses the extremely secure AES encryption method.
- **Wireless MAC Access Control.** The Wireless Access Control feature can check the MAC address (hardware address) of Wireless stations to ensure that only trusted Wireless Stations can access your LAN.
- **Simple Configuration.** If the default settings are unsuitable, they can be changed quickly and easily.
- **WDS Support.** Support for WDS (Wireless Distribution System) allows the Wireless Access Point to act as a Wireless Bridge. Both Point-to-Point and Multi-Point Bridge modes are supported.

- **WPS Support.** WPS (Wi-Fi Protected Setup) can simplify the process of connecting any device to the wireless network by using the push button configuration (PBC) on the Wireless Access Point, or entering a 8-digit PIN code if there's no button.

LAN Features

- **4-Port Switching Hub.** The Wireless Router incorporates a 4-port 10/100BaseT switching hub, making it easy to create or extend your LAN.
- **DHCP Server Support.** Dynamic Host Configuration Protocol provides a dynamic IP address to PCs and other devices upon request. The Wireless Router can act as a **DHCP Server** for devices on your local LAN and WLAN.
- **Multi Segment LAN Support.** LANs containing one or more segments are supported, via the Wireless Router's RIP (Routing Information Protocol) support and built-in static routing table.

Configuration & Management

- **Easy Setup.** Use your WEB browser from anywhere on the LAN or WLAN for configuration.
- **Configuration File Upload/Download.** Save (download) the configuration data from the Wireless Router to your PC, and restore (upload) a previously-saved configuration file to the Wireless Router.
- **Remote Management.** The Wireless Router can be managed from any PC on your LAN. And, if the Internet connection exists, it can also (optionally) be configured via the Internet.
- **Network Diagnostics.** You can use the Wireless Router to perform a *Ping* or *DNS lookup*.
- **UPnP Support.** UPnP (Universal Plug and Play) allows automatic discovery and configuration of the Wireless Router. UPnP is by supported by Windows ME, XP, or later.

Security Features

- **Password - protected Configuration.** Optional password protection is provided to prevent unauthorized users from modifying the configuration data and settings.
- **Wireless LAN Security.** WEP (Wired Equivalent Privacy) is supported, as well as Wireless access control to prevent unknown wireless stations from accessing your LAN.
- **NAT Protection.** An intrinsic side effect of NAT (Network Address Translation) technology is that by allowing all LAN users to share a single IP address, the location and even the existence of each PC is hidden. From the external viewpoint, there is no network, only a single device - the Wireless Router.
- **Stateful Inspection Firewall.** All incoming data packets are monitored and all incoming server requests are filtered, thus protecting your network from malicious attacks from external sources.
- **Protection against DoS attacks.** DoS (Denial of Service) attacks can flood your Internet connection with invalid packets and connection requests, using so much bandwidth and so many resources that Internet access becomes unavailable. The Wireless Router incorporates protection against DoS attacks.

Package Contents

The following items should be included:

- The Wireless Router Unit
- Power Adapter
- Quick Installation Guide
- CD-ROM containing the on-line manual.

If any of the above items are damaged or missing, please contact your dealer immediately.

Setup Basic Information

Default Setting:

- IP Address: 192.168.1.254
- Subnet Mask: 255.255.255.0
- Login: admin
- Password: airlive
- Default SSID: airlive
- Default Channel: 6

Physical Details

Front-mounted LEDs

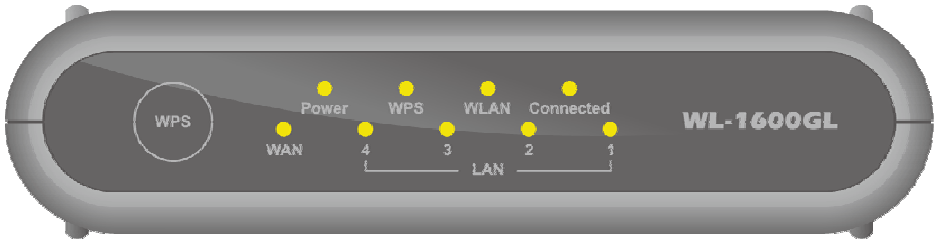

Figure 2: Front Panel

- Power LED** **On** - Power on.
Off - No power.
- WLAN LED** **On** - Idle.
Off - Error - No Wireless connection available.
Flashing - Data is being transmitted or received via the Wireless access point. This includes "network traffic" as well as user data.
- Internet LED** **On** - Internet connection is available.
Off - No Internet connection available.
Flashing - Data is being transmitted or received.
- WAN LED** **On** - Connection to the Broadband Modem attached to the WAN (Internet) port is established.
Off - No connection to the Broadband Modem.
Flashing - Data is being transmitted or received via the WAN port.
- WPS Button** • Press for the WPS Connection
- LAN LEDs** For each port, there are 1 LED
- **10 (Orange)/100 (Green)**
 - **On** - Corresponding LAN (hub) port is active.
 - **Off** - No active connection on the corresponding LAN (hub) port.
 - **Flashing** - Data is being transmitted or received via the corresponding LAN (hub) port.

Rear Panel

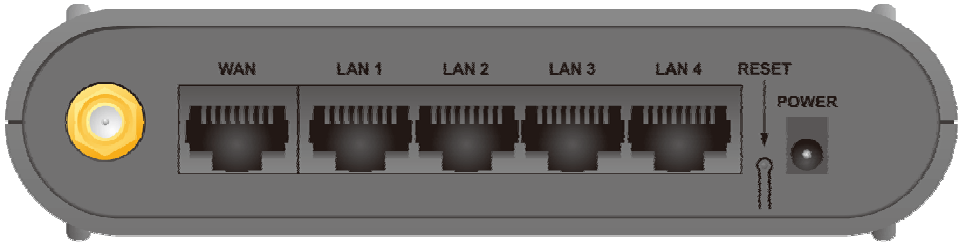

Figure 3: Rear Panel

- Antenna** One 2 dbi antenna.
- WAN** Connect the DSL or Cable Modem here. If your modem came with a cable, use the supplied cable. Otherwise, use a standard LAN cable.
- LAN** Use standard LAN cables (RJ45 connectors) to connect your PCs to these ports.
- Reset Button** This button has two (2) functions:
- **Reboot.** When pressed and released, the Wireless Router will reboot (restart).
 - **Clear All Data.** This button can also be used to clear ALL data and restore ALL settings to the factory default values.
- To Clear All Data and restore the factory default values:
1. Power Off.
 2. Hold the Reset Button down while you Power On.
 3. Keep holding the Reset Button for a few seconds, until the RED LED has flashed TWICE.
 4. Release the Reset Button. The Wireless Router is now using the factory default values.
- Power port** Connect the supplied power adapter here.

Chapter 2

Installation

2

This Chapter covers the physical installation of the Wireless Router.

Requirements

- Network cables. Use standard 10/100BaseT network (UTP) cables with RJ45 connectors.
- TCP/IP protocol must be installed on all PCs.
- For Internet Access, an Internet Access account with an ISP, and either of a DSL or Cable modem (for WAN port usage)
- To use the Wireless Access Point, all Wireless devices must be compliant with the IEEE802.11b or IEEE802.11g specifications.

Procedure

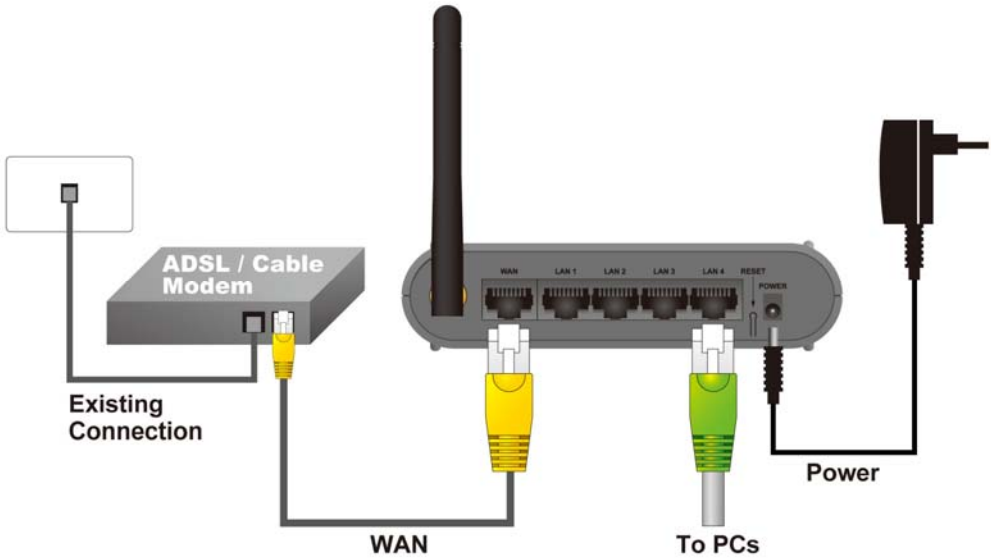

Figure 4: Installation Diagram

1. Choose an Installation Site

Select a suitable place on the network to install the Wireless Router.
Ensure the Wireless Router and the DSL/Cable modem are powered OFF.



Note!

For best Wireless reception and performance, the Wireless Router should be positioned in a central location with minimum obstructions between the Wireless Router and the PCs.

Also, if using multiple Access Points, adjacent Access

Points should use different Channels.

2. Connect LAN Cables

Use standard LAN cables to connect PCs to the Switching Hub ports on the Wireless Router. Both 10BaseT and 100BaseT connections can be used simultaneously.

If required, connect any port to a normal port on another Hub, using a standard LAN cable. Any LAN port on the Wireless Router will automatically function as an "Uplink" port when required.

3. Connect WAN Cable

Connect the DSL or Cable modem to the WAN port on the Wireless Router. Use the cable supplied with your DSL/Cable modem. If no cable was supplied, use a standard cable.

4. Power Up

- Power on the Cable or DSL modem.
- Connect the supplied power adapter to the Wireless Router and power up. Use only the power adapter provided. Using a different one may cause hardware damage

5. Check the LEDs

- The *Power* LED should be ON.
- The *Status* LED should flash, then turn Off. If it stays on, there is a hardware error.
- For each LAN (PC) connection, the LAN *Link/Act* LED should be ON (provided the PC is also ON.)
- The *WAN* LED should be ON.
- The *WLAN* LED should be ON

For more information, refer to *Front-mounted LEDs* in Chapter 1.

Chapter 3

Setup



This Chapter provides Setup details of the Wireless Router.

Overview

This chapter describes the setup procedure for:

- Internet Access
- LAN configuration
- Wireless setup
- Assigning a Password to protect the configuration data.

PCs on your local LAN may also require configuration. For details, see *Chapter 4 - PC Configuration*.

Other configuration may also be required, depending on which features and functions of the Wireless Router you wish to use. Use the table below to locate detailed instructions for the required functions.

To Do this:	Refer to:
Configure PCs on your LAN.	Chapter 4: PC Configuration
Check Wireless Router operation and Status.	Chapter 5: Operation and Status
Use any of the following Advanced features: <ul style="list-style-type: none">• Access Control• Dynamic DNS• Internet (Special Applications, DMZ)• Virtual Servers (Port Forwarding)• WAN Port	Chapter 6: Advanced Features

<p>Use any of the following Administration Configuration settings or features:</p> <ul style="list-style-type: none">• Config File download/upload• Logs• Network Diagnostics (Ping, DNS Lookup)• Options (Backup DNS, UPnP)• PC Database• QoS• Remote Management• Routing (RIP and static Routing)• Security settings• Upgrade Firmware	<p>Chapter 7 Advanced Administration</p>
---	--

Configuration Program

The Wireless Router contains an HTTP server. This enables you to connect to it, and configure it, using your Web Browser. **Your Browser must support JavaScript.**

The configuration program has been tested on the following browsers:

- Netscape V4.08 or later
- Internet Explorer V4 or later

Preparation

Before attempting to configure the Wireless Router, please ensure that:

- Your PC can establish a physical connection to the Wireless Router. The PC and the Wireless Router must be directly connected (using the Hub ports on the Wireless Router) or on the same LAN segment.
- The Wireless Router must be installed and powered ON.
- If the Wireless Router's default IP Address (192.168.1.254) is already used by another device, the other device must be turned OFF until the Wireless Router is allocated a new IP Address during configuration.

Using UPnP

If your Windows system supports UPnP, an icon for the Wireless Router will appear in the system tray, notifying you that a new network device has been found, and offering to create a new desktop shortcut to the newly-discovered device.

- Unless you intend to change the IP Address of the Wireless Router, you can accept the desktop shortcut.
- Whether you accept the desktop shortcut or not, you can always find UPnP devices in *My Network Places* (previously called *Network Neighborhood*).
- Double - click the icon for the Wireless Router (either on the Desktop, or in *My Network Places*) to start the configuration. Refer to the following section *Setup Wizard* for details of the initial configuration process.

Using your Web Browser

To establish a connection from your PC to the Wireless Router:

1. After installing the Wireless Router in your LAN, start your PC. If your PC is already running, restart it.
2. Start your WEB browser.
3. In the *Address* box, enter "HTTP://" and the IP Address of the Wireless Router, as in this example, which uses the Wireless Router's default IP Address:

```
HTTP://192.168.1.254
```

Because the default password is blank, you will not be prompted for a password. However, you should assign a password. See the *Password* section later in this chapter for details.

If you can't connect

If the Wireless Router does not respond, check the following:

- The Wireless Router is properly installed, LAN connection is OK, and it is powered ON. You can test the connection by using the "Ping" command:
 - Open the MS-DOS window or command prompt window.
 - Enter the command:

```
ping 192.168.1.254
```

If no response is received, either the connection is not working, or your PC's IP address is not compatible with the Wireless Router's IP Address. (See next item.)
- If your PC is using a fixed IP Address, its IP Address must be within the range 192.168.1.2 to 192.168.0.254 to be compatible with the Wireless Router's default IP Address of 192.168.1.254. Also, the *Network Mask* must be set to 255.255.255.0. See *Chapter 4 - PC Configuration* for details on checking your PC's TCP/IP settings.
- Ensure that your PC and the Wireless Router are on the same network segment. (If you don't have a router, this must be the case.)
- Ensure you are using the wired LAN interface. The Wireless interface can only be used if its configuration matches your PC's wireless settings.

Setup Wizard

The first time you connect to the Wireless Router, the Setup Wizard will run automatically. (The Setup Wizard will also run if the Wireless Router's default settings are restored.)

- Step through the Wizard until finished.
 - You need to know the type of Internet connection service used by your ISP. Check the data supplied by your ISP.
 - The common connection types are explained in the tables below.
- On the final screen of the Wizard, run the test and check that an Internet connection can be established.
- If the connection test fails:
 - Check your data, the Cable/DSL modem, and all connections.
 - Check that you have entered all data correctly.
 - If using a Cable modem, your ISP may have recorded the MAC (physical) address of your PC. Run the Wizard, and on the *Cable Modem* screen, use the "Clone MAC address" button to copy the MAC address from your PC to the Wireless Router.

Common Connection Types

Cable Modems

Type	Details	ISP Data required
Dynamic IP Address	Your IP Address is allocated automatically, when you connect to you ISP.	Usually, none. However, some ISP's may require you to use a particular Hostname, Domain name, or MAC (physical) address.
Static (Fixed) IP Address	Your ISP allocates a permanent IP Address to you.	IP Address allocated to you. Some ISP's may also require you to use a particular Hostname, Domain name, or MAC (physical) address.

DSL Modems

Type	Details	ISP Data required
Dynamic IP Address	Your IP Address is allocated automatically, when you connect to you ISP.	None.
Static (Fixed) IP Address	Your ISP allocates a permanent IP Address to you.	IP Address allocated to you.
PPPoE	You connect to the ISP only when required. The IP address is usually allocated automatically.	User name and password.

PPTP	<p>PPTP is mainly used in Europe.</p> <p>You connect to the ISP only when required. The IP address is usually allocated automatically, but may be Static (Fixed).</p>	<ul style="list-style-type: none"> • Server IP Address. • User name and password. • IP Address allocated to you, if Static (Fixed).
------	---	--

Other Modems (e.g. Broadband Wireless)

Type	Details	ISP Data required
Dynamic IP Address	Your IP Address is allocated automatically, when you connect to you ISP.	None.
Static (Fixed) IP Address	Your ISP allocates a permanent IP Address to you.	IP Address allocated to you.

Big Pond (Australia)

For this connection method, the following data is required:

- User Name
- Password
- Big Pond Server IP address

SingTel RAS

For this connection method, the following data is required:

- User Name
- Password
- RAS Plan

Home Screen

After finishing the Setup Wizard, you will see the *Home* screen. When you connect in future, you will see this screen when you connect. An example screen is shown below.

Router Setup

- Setup Wizard
- LAN
- Wireless
- Status
- + Internet
- + Security
- + Other

Log Out

Wireless Router

OVFFC810

Internet: IP Address: _____
 Connection Method: PPPoE

Wireless: SSID: airlive
 Security: Disabled

LAN: IP Address: 192.168.1.254
 DHCP Server: Enabled

Figure 5: Home Screen

Navigation & Data Input

- Use the menu bar on the left of the screen, and the "Back" button on your Browser, for navigation.
- Changing to another screen without clicking "Save" does NOT save any changes you may have made. You must "Save" before changing screens or your data will be ignored.



On each screen, clicking the "Help" button will display help for that screen.

From any help screen, you can access the list of all help files (help index).

LAN Screen

Use the LAN link on the main menu to reach the LAN screen. An example screen is shown below.

LAN

TCP/IP

IP Address: . . .

Subnet Mask: . . .

[DHCP Server](#) Start IP Address: . . .

Finish IP Address: . . .

Figure 6: LAN Screen

Data - LAN Screen

TCP/IP	
IP Address	IP address for the Wireless Router, as seen from the local LAN. Use the default value unless the address is already in use or your LAN is using a different IP address range. In the latter case, enter an unused IP Address from within the range used by your LAN.
Subnet Mask	The default value 255.255.255.0 is standard for small (class "C") networks. For other networks, use the Network Mask for the LAN segment to which the Wireless Router is attached. i.e. the same value as the PCs on that LAN segment.
DHCP Server	<ul style="list-style-type: none"> • If Enabled, the Wireless Router will allocate IP Addresses to PCs (DHCP clients) on your LAN when they start up. The default (and recommended) value is Enabled. • If you are already using a DHCP Server, this setting must be Disabled, and the existing DHCP server must be re-configured to treat the Wireless Router as the default Gateway. See the following section for further details. • The Start IP Address and Finish IP Address fields set the values used by the DHCP server when allocating IP Addresses to DHCP clients. This range also determines the number of DHCP clients supported. <p>See the following section for further details on using DHCP.</p>
Buttons	
Save	Save any changes you have made. Note that if you change the Wireless Router's IP address, your connection will be lost. You will have to re-connect using the new IP address.
Cancel	The "Cancel" button will discard any data you have entered and reload the file from the Wireless Router.

DHCP

What DHCP Does

A DHCP (Dynamic Host Configuration Protocol) **Server** allocates a valid IP address to a DHCP **Client** (PC or device) upon request.

- The client request is made when the client device starts up (boots).
- The DHCP Server provides the *Gateway* and *DNS* addresses to the client, as well as allocating an IP Address.
- The Wireless Router can act as a **DHCP server**.
- Windows 95/98/ME and other non-Server versions of Windows will act as a DHCP **client**. This is the default Windows setting for the TCP/IP network protocol. However, Windows uses the term *Obtain an IP Address automatically* instead of "DHCP Client".
- You must NOT have two (2) or more DHCP Servers on the same LAN segment. (If your LAN does not have other Routers, this means there must only be one (1) DHCP Server on your LAN.)

Using the Wireless Router's DHCP Server

This is the default setting. The DHCP Server settings are on the *LAN* screen. On this screen, you can:

- Enable or Disable the Wireless Router's *DHCP Server* function.
- Set the range of IP Addresses allocated to PCs by the DHCP Server function.



You can assign Fixed IP Addresses to some devices while using DHCP, provided that the Fixed IP Addresses are NOT within the range used by the DHCP Server.

Using another DHCP Server

You can only use one (1) DHCP Server per LAN segment. If you wish to use another DHCP Server, rather than the Wireless Router's, the following procedure is required.

1. Disable the DHCP Server feature in the Wireless Router. This setting is on the LAN screen.
2. Configure the DHCP Server to provide the Wireless Router's IP Address as the *Default Gateway*.

To Configure your PCs to use DHCP

This is the default setting for TCP/IP under Windows 95/98/ME.

See *Chapter 4 - Client Configuration* for the procedure to check these settings.

Wireless Screen

The Wireless Router's settings must match the other Wireless stations.

Note that the Wireless Router will automatically accept both 802.11b and 802.11g connections, and no configuration is required for this feature.

To change the Wireless Router's default settings for the Wireless Access Point feature, use the *Wireless* link on the main menu to reach the **Wireless** screen. An example screen is shown below.

Wireless

Identification	Region:	<input type="text" value="— Select Region —"/>
	Station Name:	OVFFC810
	SSID (Service Set Identifier):	<input type="text" value="airlive"/>
Options	802.11 Mode:	<input type="text" value="Auto"/>
	Channel No:	<input type="text" value="6"/>
	<input checked="" type="checkbox"/> Broadcast SSID	
	<input checked="" type="checkbox"/> Enable WMM	
Wireless Security	Current Setting:	Disabled
		<input type="button" value="Configure"/>
MAC Level Access Control	Allow LAN access by:	
	<input checked="" type="radio"/> ALL Wireless stations	
	<input type="radio"/> Selected Wireless stations only	<input type="button" value="Select Stations"/>
	Allow Internet access by:	
<input checked="" type="radio"/> ALL Wireless stations		
<input type="radio"/> Selected Wireless stations only	<input type="button" value="Select Stations"/>	
WDS	<input type="button" value="WDS Setup"/>	
WPS	<input type="button" value="Wi-Fi Protected Setup"/>	
	<input type="button" value="Save"/>	<input type="button" value="Cancel"/> <input type="button" value="Help"/>

Figure 7: Wireless Screen

Data - Wireless Screen

Identification	
Region	Select your region from the drop-down list. This field displays the region of operation for which the wireless interface is intended. It may not be legal to operate the router in a region other than the region shown here. If your country or region is not listed, please check with your local government agency for more information on which channels you are allowed to use, and select a region which allows those channels. (The channel list changes according to the selected region.)
Station name	On your PC, some Wireless status screens may display this name as the Access Point in use.
SSID	<ul style="list-style-type: none"> • If using an ESS (Extended Service Set, with multiple access points) this ID is called an ESSID (Extended Service Set Identifier). • To communicate, all Wireless stations should use the same SSID/ESSID.
Options	
802.11 Mode	<p>Select the desired mode:</p> <ul style="list-style-type: none"> • Auto - This is the default, and should normally be used. • 802.11g - Only 802.11g Wireless stations can use the Wireless Router. • 802.11b - Only 802.11b connections are available. 802.11g Wireless Stations will only be able to use the Wireless Router if they are fully backward-compatible with the 802.11b standard. • G Plus - Only 802.11G Plus connections are available.
Channel No.	This field determines which operating frequency will be used. It should not be necessary to change the wireless channel unless you notice interference problems with another nearby access point.
Broadcast SSID	If Enabled, the SSID will broadcast its name to all Wireless Stations. Stations which have no SSID (or a "null" value) can then adopt the correct SSID for connections to this Access Point.
WMM Support	Enable or disable this feature as required.
Wireless Security	
Current Setting	The current security setting is displayed.
Configure Button	Click this button to access the Wireless security sub-screen, and modify the security settings as required. See the following section for details.
MAC Access Control	
Allow LAN access	<ul style="list-style-type: none"> • All Wireless Stations - All wireless stations can use the access point to access your LAN. • Selected Wireless stations only - Only selected wireless stations access your LAN. To select the required wireless stations, click the "Select Stations" button.

Allow Internet access	<ul style="list-style-type: none"> • All Wireless Stations - All wireless stations can use the access point to access the Internet. • Selected Wireless stations only - Only selected wireless stations use the access point to access the Internet. To select the required wireless stations, click the "Select Stations" button.
Buttons	
Configure	Click this button to view the Wireless security sub-screen.
Select Stations	Click this button to select the required PCs.
Wi-Fi Protected Setup	Click this button to open a sub-screen where you can modify the "WPS" settings. See the following section for more details.
Save	Save the data on screen.
Cancel	The "Cancel" button will discard any data you have entered since the last "Save" operation.

Wireless Security Screen

This screen is accessed by clicking the "Configure" button on the *Wireless* screen. There are 3 options for Wireless security:

- **Disabled** - no data encryption is used.
- **WEP** - data is encrypted using the WEP standard.
- **WPA/WPA2-PSK** - data is encrypted using the WPA standard. This is a later standard than WEP, and provides much better security than WEP.

Wireless Security - WEP



Figure 8: WEP Screen

Data - WEP Screen

Authentication	Normally this can be left at the default value of "Auto". If that fails, select the appropriate value - "Open System" or "Shared Key." Check your wireless card's documentation to see what method to use.
-----------------------	--

Key Size	Select the WEP Encryption level: <ul style="list-style-type: none"> • 64-bit (sometimes called 40-bit) encryption • 128-bit encryption
Passphrase	Enter a word or group of printable characters in the Passphrase box and click the "Generate " button to automatically configure the WEP Key(s). If encryption strength is set to 64 bit, then each of the four key fields will be populated with key values. If encryption strength is set to 128 bit, then only the selected WEP key field will be given a key value.
Key	<ul style="list-style-type: none"> • Use the radio buttons to select the default key. • Enter the key value you wish to use. Other stations must have the same key values. • Keys must be entered in Hex. Hex characters are the digits (0 ~ 9) and the letters A ~ F.

Wireless Security - WPA/WPA2-PSK

If "WPA1/2-PSK" is selected, the screen will look like the following example.

Wireless Security

Security System WPA/WPA2-PSK ▼

WPA/WPA2-PSK

Authentication: WPA-PSK ▼

Passphrase (PSK):
(8 to 63 characters)

Key Lifetime: 3600 (secs)

Encryption: TKIP ▼

Save
Cancel

Help
Close

Figure 9: WPA/WPA2-PSK Screen

Data - WPA/WPA2-PSK screen

Authentication	Select the desired option: <ul style="list-style-type: none"> • WPA-PSK: Like WEP, data is encrypted before transmission. WPA is more secure than WEP, and should be used if possible. • WPA2-PSK: This is a further development of WPA-PSK, and offers even greater security. • WPAM-PSK(Mixed): This method, sometimes called "Mixed Mode", allows clients to use EITHER WPA-PSK OR WPA2-PSK.
Passphrase (PSK)	Enter the Network key value. Data is encrypted using a key derived from the network key. Other Wireless Stations must use the same

	network key. The PSK must be from 8 to 63 characters in length.
Key Lifetime	This determines how often the encryption key is changed. Enter the desired value.
Encryption	Select the desired option. Wireless Stations must use the same method.

Wi-Fi Protected Setup

Click *Wi-Fi Protected Setup* on the Wireless screen to view a screen like the following.

The screenshot shows the 'Wi-Fi Protected Setup' configuration screen. It features a blue header with the title. Below the header, there are two radio button options. The first option, 'Enable WPS', is checked. The second option, 'Input Enrollee's PIN:', is followed by an empty text input field. The third option, 'Change AP Settings', is selected and followed by a text input field containing the number '42574491' and an 'Auto Generate' button. At the bottom of the screen, there are three buttons: 'Save', 'Cancel', and 'Help'.

Figure 10: Wi-Fi Protected Setup Screen

Data - Wi-Fi Protected Setup Screen

WPS PIN	
Input Enrollee's PIN	Enter the PIN code and click <i>Add Client to AP</i> to add the client device.
Change AP Settings	Click the <i>Auto Generate</i> button to have the new pin code displayed in the field.

Password Screen

The password screen allows you to assign a password to the Wireless Router.

Password

Password The password protects the configuration data. Once set (recommended), you will be prompted for the password when you connect.

Current password:	<input type="text"/>
New password:	<input type="password"/>
Verify password:	<input type="password"/>

Figure 11: Password Screen

Once you have assigned a password to the Wireless Router (on the *Password* screen above) you will be prompted for the password when you connect, as shown below. (If no password has been set, this dialog will not appear.)

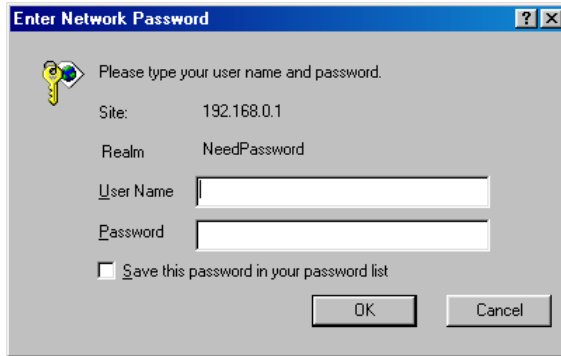

Figure 12: Password Dialog

- Leave the "User Name" blank.
- Enter the password for the Wireless Router, as set on the *Password* screen above.

Chapter 4

4

PC Configuration

This Chapter details the PC Configuration required on the local ("Internal") LAN.

Overview

For each PC, the following may need to be configured:

- TCP/IP network settings
- Internet Access configuration
- Wireless configuration

Windows Clients

This section describes how to configure Windows clients for Internet access via the Wireless Router.

The first step is to check the PC's TCP/IP settings.

The Wireless Router uses the TCP/IP network protocol for all functions, so it is essential that the TCP/IP protocol be installed and configured on each PC.

TCP/IP Settings - Overview

If using the default Wireless Router settings, and the default Windows TCP/IP settings, no changes need to be made.

- By default, the Wireless Router will act as a DHCP Server, automatically providing a suitable IP Address (and related information) to each PC when the PC boots.
- For all non-Server versions of Windows, the default TCP/IP setting is to act as a DHCP client.

If using a Fixed (specified) IP address, the following changes are required:

- The *Gateway* must be set to the IP address of the Wireless Router
- The *DNS* should be set to the address provided by your ISP.



If your LAN has a Router, the LAN Administrator must re-configure the Router itself. Refer to *Chapter 8 - Advanced Setup* for details.

Checking TCP/IP Settings - Windows 9x/ME:

1. Select *Control Panel - Network*. You should see a screen like the following:

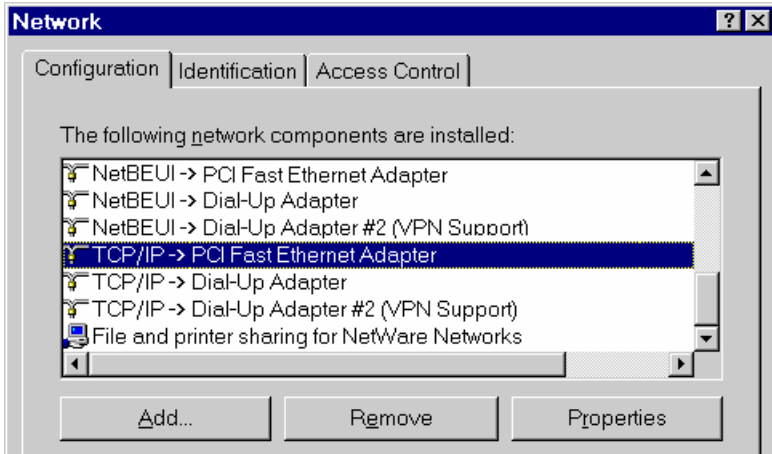

Figure 13: Network Configuration

2. Select the *TCP/IP* protocol for your network card.
3. Click on the *Properties* button. You should then see a screen like the following.

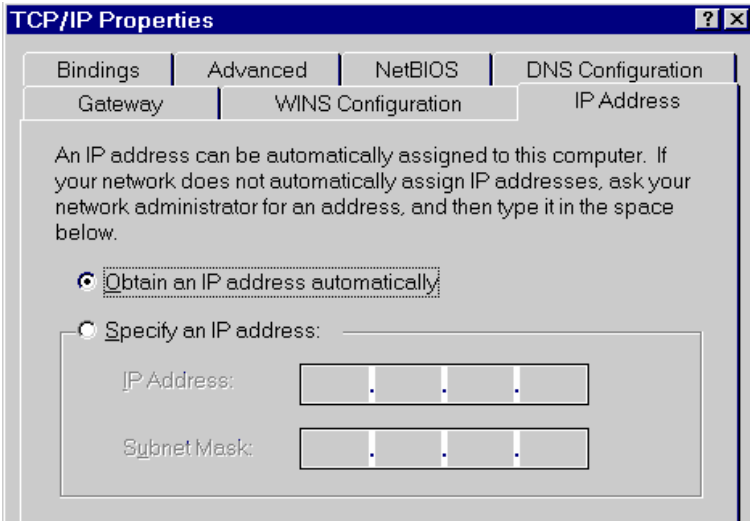

Figure 14: IP Address (Win 95)

Ensure your TCP/IP settings are correct, as follows:

Using DHCP

To use DHCP, select the radio button *Obtain an IP Address automatically*. This is the default Windows setting. **Using this is recommended.** By default, the Wireless Router will act as a DHCP Server.

Restart your PC to ensure it obtains an IP Address from the Wireless Router.

Using "Specify an IP Address"

If your PC is already configured, check with your network administrator before making the following changes:

- On the *Gateway* tab, enter the Wireless Router's IP address in the *New Gateway* field and click *Add*, as shown below. Your LAN administrator can advise you of the IP Address they assigned to the Wireless Router.

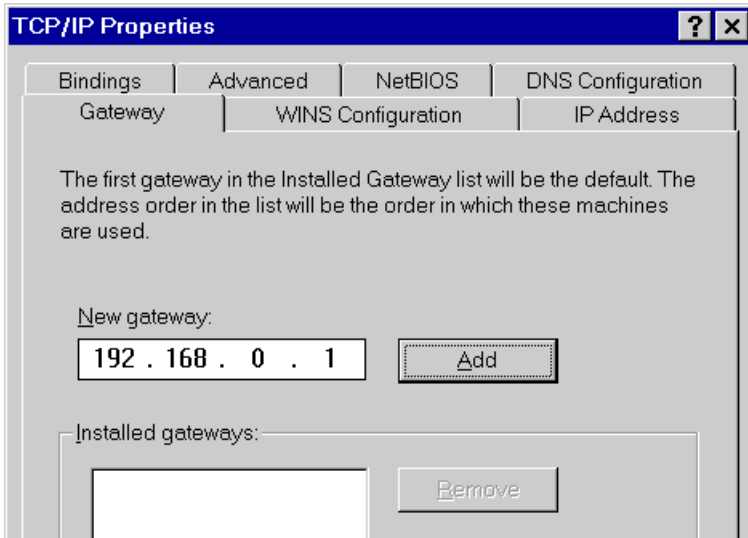

Figure 15: Gateway Tab (Win 95/98)

- On the *DNS Configuration* tab, ensure *Enable DNS* is selected. If the *DNS Server Search Order* list is empty, enter the DNS address provided by your ISP in the fields beside the *Add* button, then click *Add*.

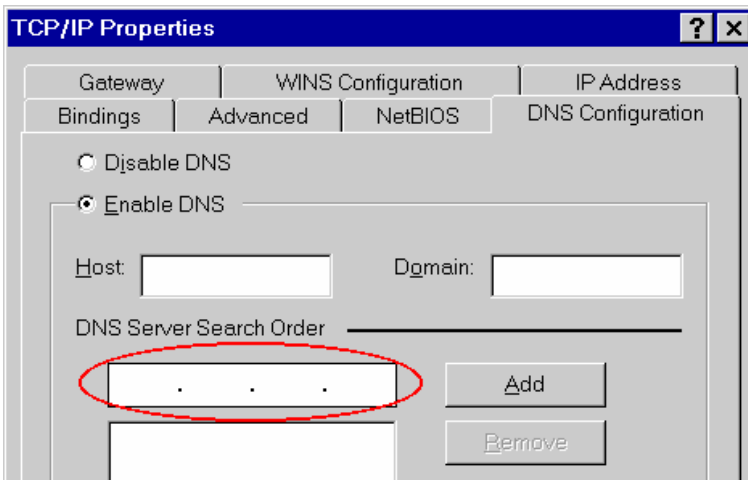

Figure 16: DNS Tab (Win 95/98)

Checking TCP/IP Settings - Windows NT4.0

1. Select *Control Panel - Network*, and, on the *Protocols* tab, select the TCP/IP protocol, as shown below.

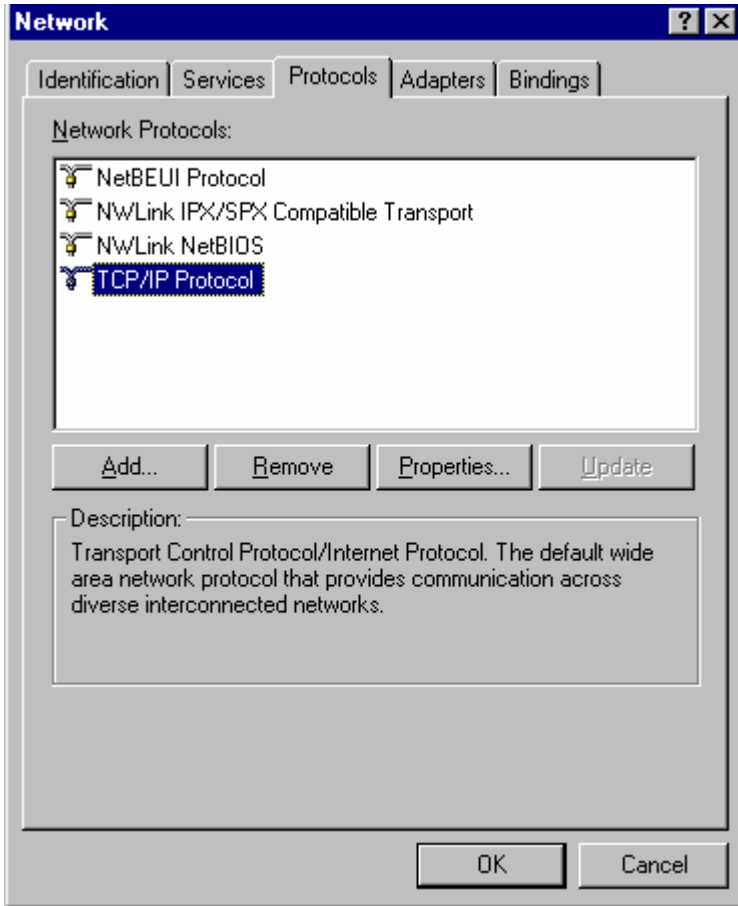

Figure 17: Windows NT4.0 - TCP/IP

2. Click the *Properties* button to see a screen like the one below.

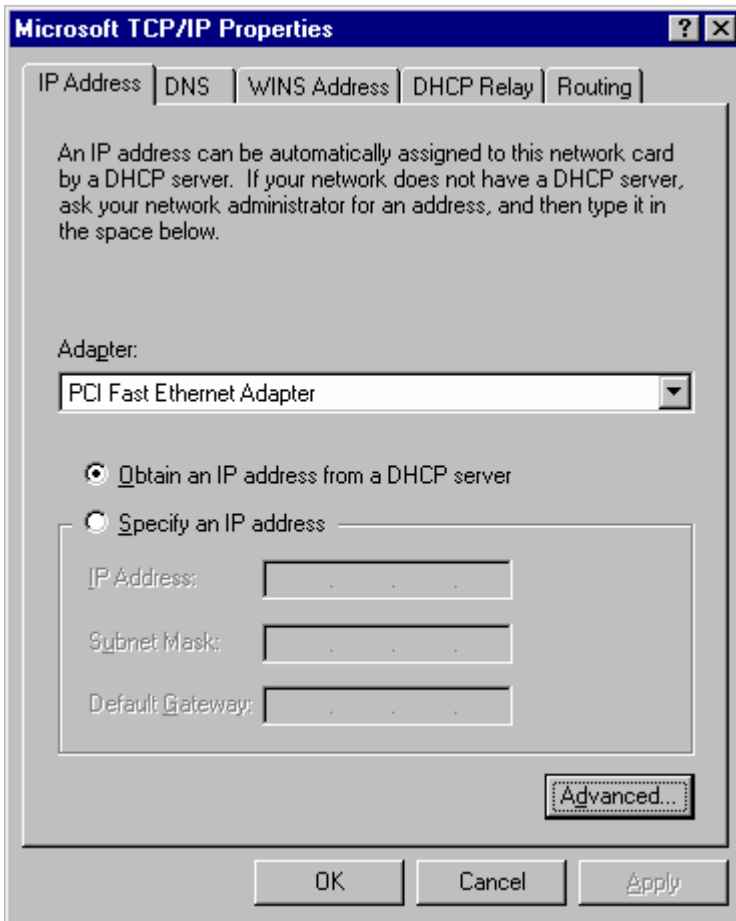

Figure 18: Windows NT4.0 - IP Address

3. Select the network card for your LAN.
4. Select the appropriate radio button - *Obtain an IP address from a DHCP Server* or *Specify an IP Address*, as explained below.

Obtain an IP address from a DHCP Server

This is the default Windows setting. **Using this is recommended.** By default, the Wireless Router will act as a DHCP Server.

Restart your PC to ensure it obtains an IP Address from the Wireless Router.

Specify an IP Address

If your PC is already configured, check with your network administrator before making the following changes.

1. The *Default Gateway* must be set to the IP address of the Wireless Router. To set this:
 - Click the *Advanced* button on the screen above.
 - On the following screen, click the *Add* button in the *Gateways* panel, and enter the Wireless Router's IP address, as shown in Figure 19 below.
 - If necessary, use the *Up* button to make the Wireless Router the first entry in the *Gateways* list.

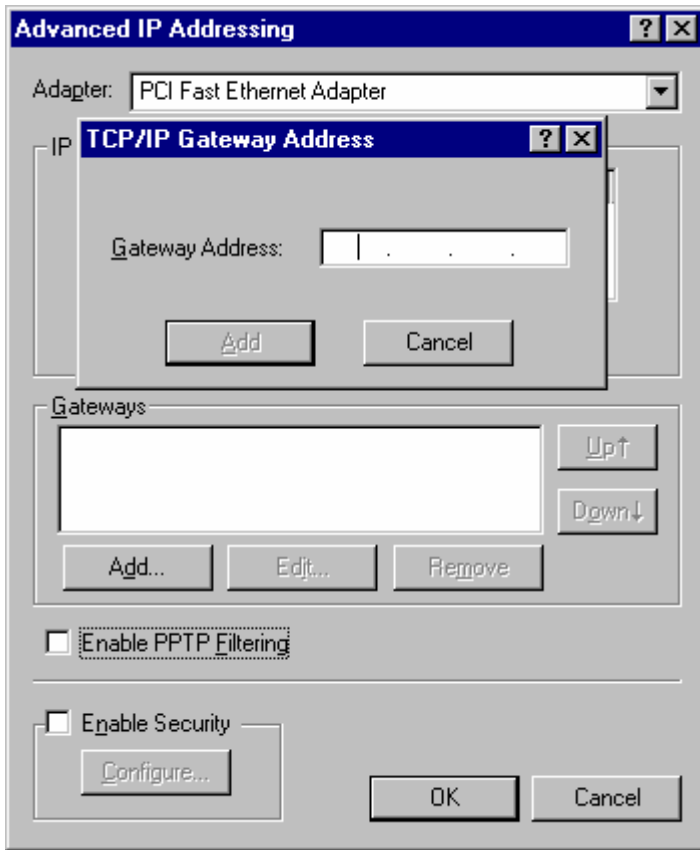

Figure 19 - Windows NT4.0 - Add Gateway

2. The DNS should be set to the address provided by your ISP, as follows:
 - Click the DNS tab.
 - On the DNS screen, shown below, click the *Add* button (under *DNS Service Search Order*), and enter the DNS provided by your ISP.

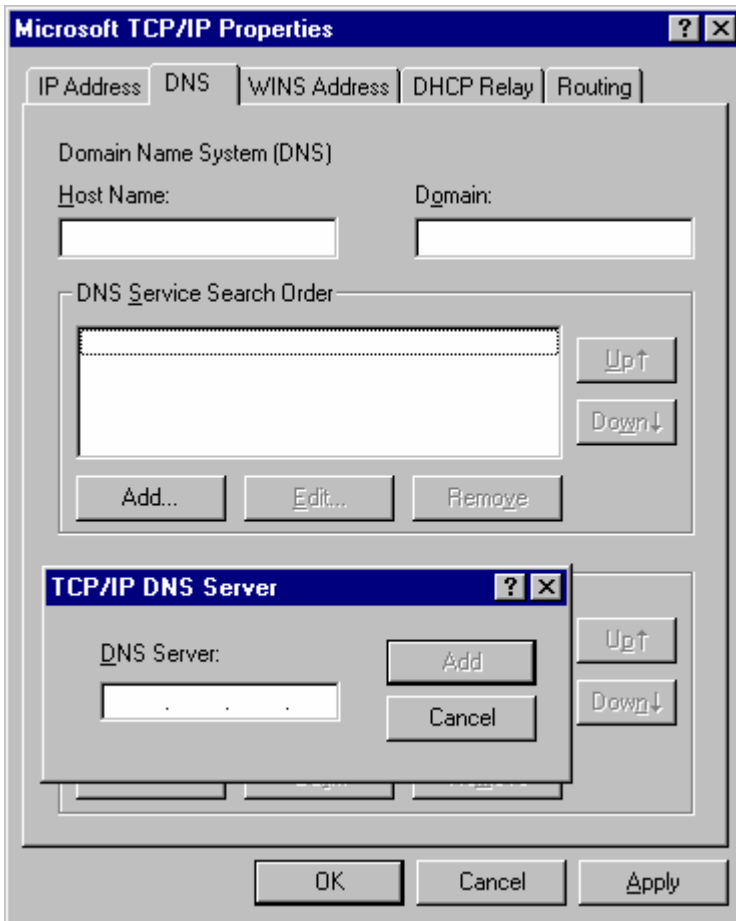

Figure 20: Windows NT4.0 - DNS

Checking TCP/IP Settings - Windows 2000:

1. Select *Control Panel - Network and Dial-up Connection*.
2. Right - click the *Local Area Connection* icon and select *Properties*. You should see a screen like the following:

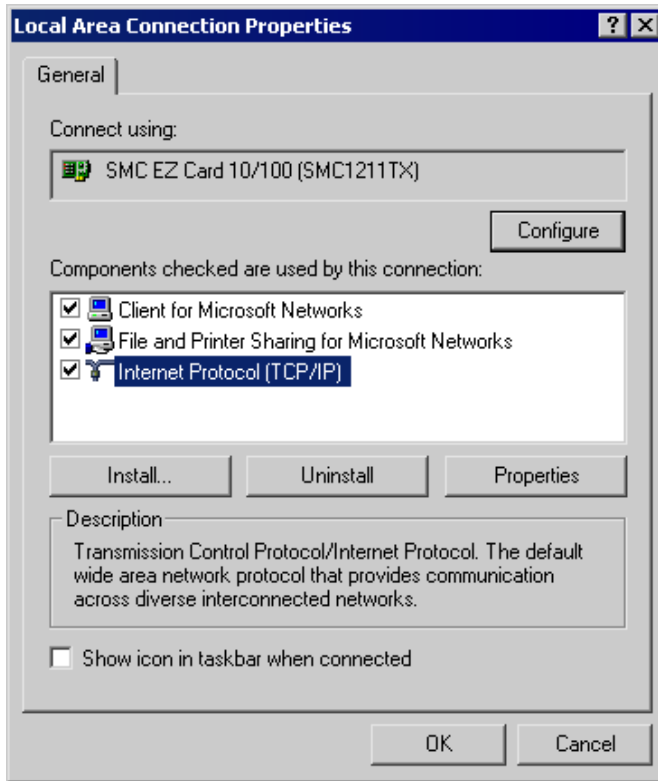

Figure 21: Network Configuration (Win 2000)

3. Select the *TCP/IP* protocol for your network card.
4. Click on the *Properties* button. You should then see a screen like the following.

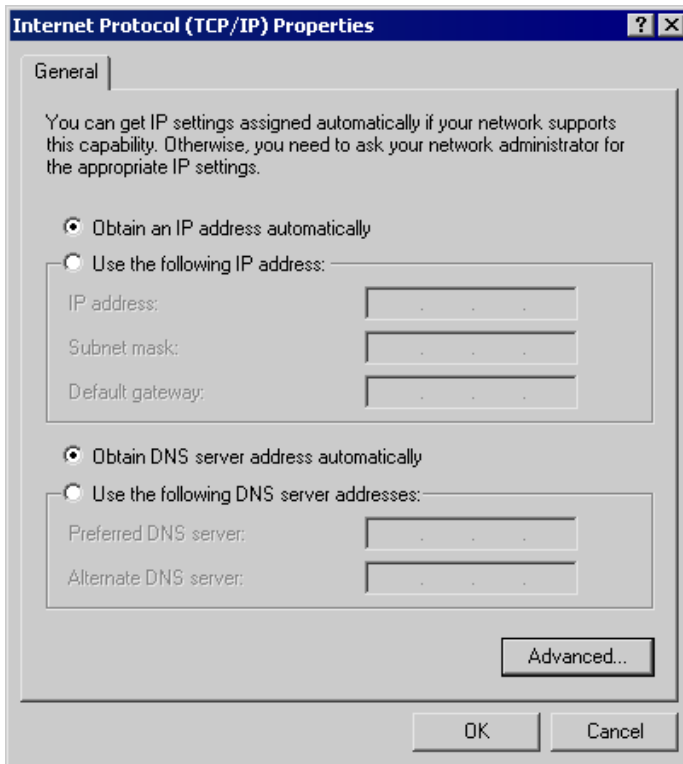

Figure 22: TCP/IP Properties (Win 2000)

5. Ensure your TCP/IP settings are correct, as described below.

Using DHCP

To use DHCP, select the radio button *Obtain an IP Address automatically*. This is the default Windows setting. **Using this is recommended.** By default, the Wireless Router will act as a DHCP Server.

Restart your PC to ensure it obtains an IP Address from the Wireless Router.

Using a fixed IP Address ("Use the following IP Address")

If your PC is already configured, check with your network administrator before making the following changes.

- Enter the Wireless Router's IP address in the *Default gateway* field and click *OK*. (Your LAN administrator can advise you of the IP Address they assigned to the Wireless Router.)
- If the *DNS Server* fields are empty, select *Use the following DNS server addresses*, and enter the DNS address or addresses provided by your ISP, then click *OK*.

Checking TCP/IP Settings - Windows XP

1. Select *Control Panel - Network Connection*.
2. Right click the *Local Area Connection* and choose *Properties*. You should see a screen like the following:

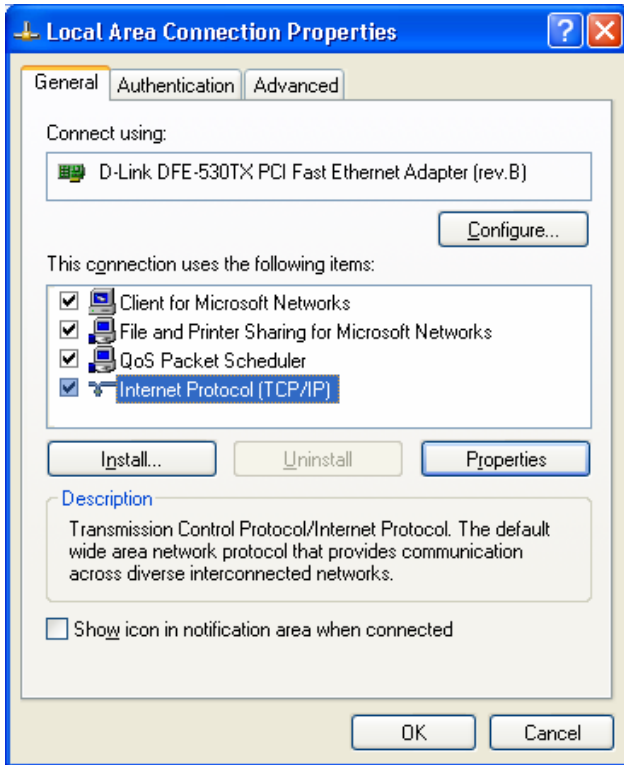

Figure 23: Network Configuration (Windows XP)

3. Select the *TCP/IP* protocol for your network card.
4. Click on the *Properties* button. You should then see a screen like the following.

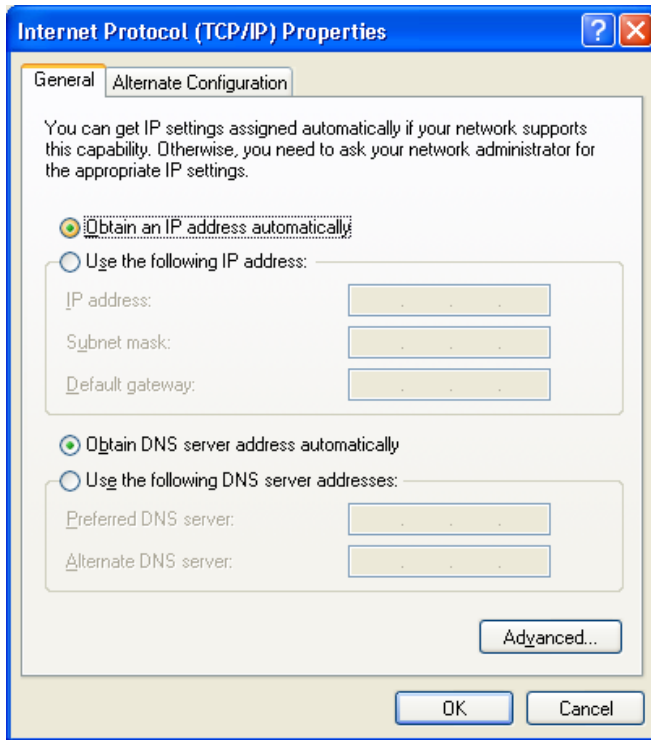

Figure 24: TCP/IP Properties (Windows XP)

5. Ensure your TCP/IP settings are correct.

Using DHCP

To use DHCP, select the radio button *Obtain an IP Address automatically*. This is the default Windows setting. **Using this is recommended.** By default, the Wireless Router will act as a DHCP Server.

Restart your PC to ensure it obtains an IP Address from the Wireless Router.

Using a fixed IP Address ("Use the following IP Address")

If your PC is already configured, check with your network administrator before making the following changes.

- In the *Default gateway* field, enter the Wireless Router's IP address and click *OK*. Your LAN administrator can advise you of the IP Address they assigned to the Wireless Router.
- If the *DNS Server* fields are empty, select *Use the following DNS server addresses*, and enter the DNS address or addresses provided by your ISP, then click *OK*.

Internet Access

To configure your PCs to use the Wireless Router for Internet access:

- Ensure that the DSL modem, Cable modem, or other permanent connection is functional.
- Use the following procedure to configure your Browser to access the Internet via the LAN, rather than by a Dial-up connection.

For Windows 9x/ME/2000

1. Select *Start Menu - Settings - Control Panel - Internet Options*.
2. Select the *Connection* tab, and click the *Setup* button.
3. Select "I want to set up my Internet connection manually, or I want to connect through a local area network (LAN)" and click *Next*.
4. Select "I connect through a local area network (LAN)" and click *Next*.
5. Ensure all of the boxes on the following Local area network Internet Configuration screen are **unchecked**.
6. Check the "No" option when prompted "Do you want to set up an Internet mail account now?".
7. Click *Finish* to close the Internet Connection Wizard.
Setup is now completed.

For Windows XP

1. Select *Start Menu - Control Panel - Network and Internet Connections*.
2. Select *Set up or change your Internet Connection*.
3. Select the *Connection* tab, and click the *Setup* button.
4. Cancel the pop-up "Location Information" screen.
5. Click *Next* on the "New Connection Wizard" screen.
6. Select "Connect to the Internet" and click *Next*.
7. Select "Set up my connection manually" and click *Next*.
8. Check "Connect using a broadband connection that is always on" and click *Next*.
9. Click *Finish* to close the New Connection Wizard.
Setup is now completed.

Accessing AOL

To access AOL (America On Line) through the Wireless Router, the *AOL for Windows* software must be configured to use TCP/IP network access, rather than a dial-up connection. The configuration process is as follows:

- Start the *AOL for Windows* communication software. Ensure that it is Version 2.5, 3.0 or later. This procedure will not work with earlier versions.
- Click the *Setup* button.
- Select *Create Location*, and change the location name from "New Locality" to "Wireless Router".
- Click *Edit Location*. Select *TCP/IP* for the *Network* field. (Leave the *Phone Number* blank.)
- Click *Save*, then *OK*.
Configuration is now complete.
- Before clicking "Sign On", always ensure that you are using the "Wireless Router" location.

Macintosh Clients

From your Macintosh, you can access the Internet via the Wireless Router. The procedure is as follows.

1. Open the TCP/IP Control Panel.
2. Select *Ethernet* from the *Connect via* pop-up menu.
3. Select *Using DHCP Server* from the *Configure* pop-up menu. The DHCP Client ID field can be left blank.
4. Close the TCP/IP panel, saving your settings.

Note:

If using manually assigned IP addresses instead of DHCP, the required changes are:

- Set the *Router Address* field to the Wireless Router's IP Address.
- Ensure your DNS settings are correct.

Linux Clients

To access the Internet via the Wireless Router, it is only necessary to set the Wireless Router as the "Gateway".

Ensure you are logged in as "root" before attempting any changes.

Fixed IP Address

By default, most Unix installations use a fixed IP Address. If you wish to continue using a fixed IP Address, make the following changes to your configuration.

- Set your "Default Gateway" to the IP Address of the Wireless Router.
- Ensure your DNS (Name server) settings are correct.

To act as a DHCP Client (recommended)

The procedure below may vary according to your version of Linux and X -windows shell.

1. Start your X Windows client.
2. Select *Control Panel - Network*
3. Select the "Interface" entry for your Network card. Normally, this will be called "eth0".
4. Click the *Edit* button, set the "protocol" to "DHCP", and save this data.
5. To apply your changes
 - Use the "Deactivate" and "Activate" buttons, if available.
 - OR, restart your system.

Other Unix Systems

To access the Internet via the Wireless Router:

- Ensure the "Gateway" field for your network card is set to the IP Address of the Wireless Router.
- Ensure your DNS (Name Server) settings are correct.

Wireless Station Configuration

This section applies to all Wireless stations wishing to use the Wireless Router's Access Point, regardless of the operating system which is used on the client.

To use the Wireless Access Point in the Wireless Router, each Wireless Station must have compatible settings, as follows:

Mode	The mode must be set to <i>Infrastructure</i> .
SSID (ESSID)	This must match the value used on the Wireless Router. The default value is airlive Note! The SSID is case sensitive.
Wireless Security	By default, Wireless security on the Wireless Router is disabled. <ul style="list-style-type: none"> • If Wireless security remains disabled on the Wireless Router, all stations must have wireless security disabled. • If Wireless security is enabled on the Wireless Router, each station must use the same settings as the Wireless Router.

Note:

By default, the Wireless Router will allow both 802.11b and 802.11g connections.

Chapter 5

5

Operation and Status

This Chapter details the operation of the Wireless Router and the status screens.

Operation

Once both the Wireless Router and the PCs are configured, operation is automatic.

However, there are some situations where additional Internet configuration may be required:

- If using Internet-based **Communication Applications**, it may be necessary to specify which PC receives an incoming connection. Refer to *Chapter 6 - Advanced Features* for further details.
- Applications which use non-standard connections or port numbers may be blocked by the Wireless Router's built-in firewall. You can define such applications as **Special Applications** to allow them to function normally. Refer to *Chapter 6 - Advanced Features* for further details.
- Some non-standard applications may require use of the **DMZ** feature. Refer to *Chapter 6 - Advanced Features* for further details.

Status Screen

Use the **Status** link on the main menu to view this screen.

Connection Status - PPPoE

Connection

Physical Address: 00-c0-02-ff-c8-11
IP Address:
Network Mask:
PPPoE Link Status: OFF

Connection Log

```
314:Unknown Code.  
313:Receive 00:11:22:33:44:56 FF:FF:FF:FF:FF:FF  
PPPoE_DISC: 1.1 PADI ID=0x0 len 12  
312:Unknown Code.  
311:Receive 00:11:22:33:44:56 FF:FF:FF:FF:FF:FF  
PPPoE_DISC: 1.1 PADI ID=0x0 len 12
```

Clear Log

Connect and Disconnect buttons should only be needed if using "Manual Connection".

Connect Disconnect Refresh Help Close

Figure 25: Status Screen

Data - Status Screen

Internet	
Connection Method	This indicates the current connection method, as set in the <i>Setup Wizard</i> or <i>WAN Port</i> screen.
Broadband Modem	This shows the status of the connection from the Wireless Router to the Broadband Modem.
Internet Connection	This shows the current connection status. If there is an error, you can click the "Connection Details" button to find out more information.
Internet IP Address	This IP Address is allocated by the ISP (Internet Service Provider). If there is no current connection, this will be blank or 0.0.0.0.
WAN MTU	This shows the current MTU size used.
"Connection Details" Button	Click this button to open a sub-window and view a detailed description of the current connection. Depending on the type of

	connection, a "Connection Log" may also be available.
LAN	
IP Address	The IP Address of the Wireless Router.
Network Mask	The Network Mask (Subnet Mask) for the IP Address above.
DHCP Server	This shows the status of the DHCP Server function - either "Enabled" or "Disabled". For additional information about the PCs on your LAN, and the IP addresses allocated to them, use the <i>PC Database</i> option on the <i>Administration</i> menu.
Wireless	
Network Name (SSID)	If using an ESS (Extended Service Set, with multiple access points) this ID is called an ESSID (Extended Service Set Identifier).
802.11 Mode	The current 802.11 mode is displayed here.
Channel	This shows the Channel currently used, as set on the Wireless screen.
Security	This indicates the Wireless security system currently used.
System	
Device Name	This displays the current name of the Wireless Router.
Firmware Version	The current version of the firmware installed in the Wireless Router.
Buttons	
Connection Details	View the details of the current Internet connection. The sub-screen displayed will depend on the connection method used. See the following sections for details of each sub-screen.
System Data	Display all system information in a sub-window.
Restart	Clicking this button will restart (reboot) the Wireless Router. All existing connections through the Wireless Router will be terminated, but will usually re-connect automatically.
Refresh Screen	Update the data displayed on screen.

Connection Status - PPPoE

If using PPPoE (PPP over Ethernet), a screen like the following example will be displayed when the "Connection Details" button is clicked.

Connection Status - PPPoE

Connection

Physical Address: 00-c0-02-ff-c8-11
IP Address:
Network Mask:
PPPoE Link Status: OFF

Connection Log

```
314:Unknown Code.  
313:Receive 00:11:22:33:44:56 FF:FF:FF:FF:FF:FF  
PPPoE_DISC: 1.1 PADI ID=0x0 len 12  
312:Unknown Code.  
311:Receive 00:11:22:33:44:56 FF:FF:FF:FF:FF:FF  
PPPoE_DISC: 1.1 PADI ID=0x0 len 12
```

Clear Log

Connect and Disconnect buttons should only be needed if using "Manual Connection".

Connect Disconnect Refresh Help Close

Figure 26: PPPoE Status Screen

Data - PPPoE Screen

Connection	
Physical Address	The hardware address of this device, as seen by remote devices on the Internet. (This is different to the hardware address seen by devices on the local LAN.)
IP Address	The IP Address of this device, as seen by Internet users. This address is allocated by your ISP (Internet Service Provider).
Network Mask	The Network Mask associated with the IP Address above.
PPPoE Link Status	This indicates whether or not the connection is currently established. <ul style="list-style-type: none">• If the connection does not exist, the "Connect" button can be used to establish a connection.• If the connection currently exists, the "Disconnect" button can be used to break the connection.

Connection Log	
Connection Log	<ul style="list-style-type: none"> • The Connection Log shows status messages relating to the existing connection. • The most common messages are listed in the table below. • The "Clear Log" button will restart the Log, while the Refresh button will update the messages shown on screen.
Buttons	
Connect	If not connected, establish a connection to your ISP.
Disconnect	If connected to your ISP, hang up the connection.
Clear Log	Delete all data currently in the Log. This will make it easier to read new messages.
Refresh	Update the data on screen.

Connection Log Messages

Message	Description
Connect on Demand	Connection attempt has been triggered by the "Connect automatically, as required" setting.
Manual connection	Connection attempt started by the "Connect" button.
Reset physical connection	Preparing line for connection attempt.
Connecting to remote server	Attempting to connect to the ISP's server.
Remote Server located	ISP's Server has responded to connection attempt.
Start PPP	Attempting to login to ISP's Server and establish a PPP connection.
PPP up successfully	Able to login to ISP's Server and establish a PPP connection.
Idle time-out reached	The connection has been idle for the time period specified in the "Idle Time-out" field. The connection will now be terminated.
Disconnecting	The current connection is being terminated, due to either the "Idle Time-out" above, or "Disconnect" button being clicked.
Error: Remote Server not found	ISP's Server did not respond. This could be a Server problem, or a problem with the link to the Server.
Error: PPP Connection failed	Unable to establish a PPP connection with the ISP's Server. This could be a login problem (name or password) or a Server problem.
Error: Connection to Server lost	The existing connection has been lost. This could be caused by a power failure, a link failure, or Server failure.
Error: Invalid or unknown packet type	The data received from the ISP's Server could not be processed. This could be caused by data corruption (from a bad link), or the Server using a protocol which is not supported by this device.

Connection Status - PPTP

If using PPTP (Peer-to-Peer Tunneling Protocol), a screen like the following example will be displayed when the "Connection Details" button is clicked.

Status

Internet	Connection Method: PPPoE Broadband Modem : Connection OK Internet Connection: Failed Internet IP Address: WAN MTU: 1500	<input type="button" value="Connection Details"/>
LAN	IP Address: 192.168.1.254 Network Mask: 255.255.255.0 DHCP Server: Enabled	
Wireless	Network Name (SSID): airlive 802.11 Mode: Auto Channel: 6 Security: Disabled	
System	Device Name: OVFFC810 Firmware Version: Version 2.0 Release 01	<input type="button" value="System Data"/>

Figure 27: PPTP Status Screen

Data - PPTP Screen

Connection	
Physical Address	The hardware address of this device, as seen by remote devices on the Internet. (This is different to the hardware address seen by devices on the local LAN.)
IP Address	The IP Address of this device, as seen by Internet users. This address is allocated by your ISP (Internet Service Provider).
Connection Status	<ul style="list-style-type: none"> This indicates whether or not the connection is currently established. If the connection does not exist, the <i>Connect</i> button can be used to establish a connection. If the connection currently exists, the <i>Disconnect</i> button can be used to break the connection.

-
- | | |
|--|--|
| | <ul style="list-style-type: none">• Normally, it is not necessary to use the <i>Connect</i> and <i>Disconnect</i> buttons unless the setting "Connect automatically, as required" is disabled. |
|--|--|
-

Connection Log

Connection Log

- The Connection Log shows status messages relating to the existing connection.
- The "Clear Log" button will restart the Log, while the Refresh button will update the messages shown on screen.

Buttons

Connect

If not connected, establish a connection to your ISP.

Disconnect

If connected to your ISP, terminate the connection.

Clear Log

Delete all data currently in the Log. This will make it easier to read new messages.

Refresh

Update the data on screen.

Connection Status - L2TP

If using L2TP, a screen like the following example will be displayed when the "Connection Details" button is clicked.

Connection Status - PPPoE

Connection

Physical Address: 00-c0-02-ff-c8-11

IP Address:

Network Mask:

PPPoE Link Status: OFF

Connection Log

```

314:Unknown Code.
313:Receive 00:11:22:33:44:56 FF:FF:FF:FF:FF:FF
PPPoE_DISC: 1.1 PADI ID=0x0 len 12
312:Unknown Code.
311:Receive 00:11:22:33:44:56 FF:FF:FF:FF:FF:FF
PPPoE_DISC: 1.1 PADI ID=0x0 len 12

```

Clear Log

Connect and Disconnect buttons should only be needed if using "Manual Connection".

Connect

Disconnect

Refresh

Help

Close

Figure 28: L2TP Status Screen

Data - L2TP Screen

Internet	
Physical Address	The hardware address of this device, as seen by remote devices on the Internet. (This is different to the hardware address seen by devices on the local LAN.)
IP Address	The IP Address of this device, as seen by Internet users. This address is allocated by your ISP (Internet Service Provider).
Connection Status	<p>This indicates whether or not the connection is currently established.</p> <ul style="list-style-type: none"> • If the connection does not exist, the <i>Connect</i> button can be used to establish a connection. • If the connection currently exists, the <i>Disconnect</i> button can be used to break the connection. • Normally, it is not necessary to use the <i>Connect</i> and <i>Disconnect</i> buttons unless the setting "Connect automatically, as required" is disabled.

Connection Log	
Connection Log	<ul style="list-style-type: none"> • The Connection Log shows status messages relating to the existing connection. • The "Clear Log" button will restart the Log, while the Refresh button will update the messages shown on screen.
Buttons	
Connect	If not connected, establish a connection to your ISP.
Disconnect	If connected to your ISP, hang up the connection.
Clear Log	Delete all data currently in the Log. This will make it easier to read new messages.
Refresh	Update the data on screen.

Connection Status - Telstra Big Pond

An example screen is shown below.

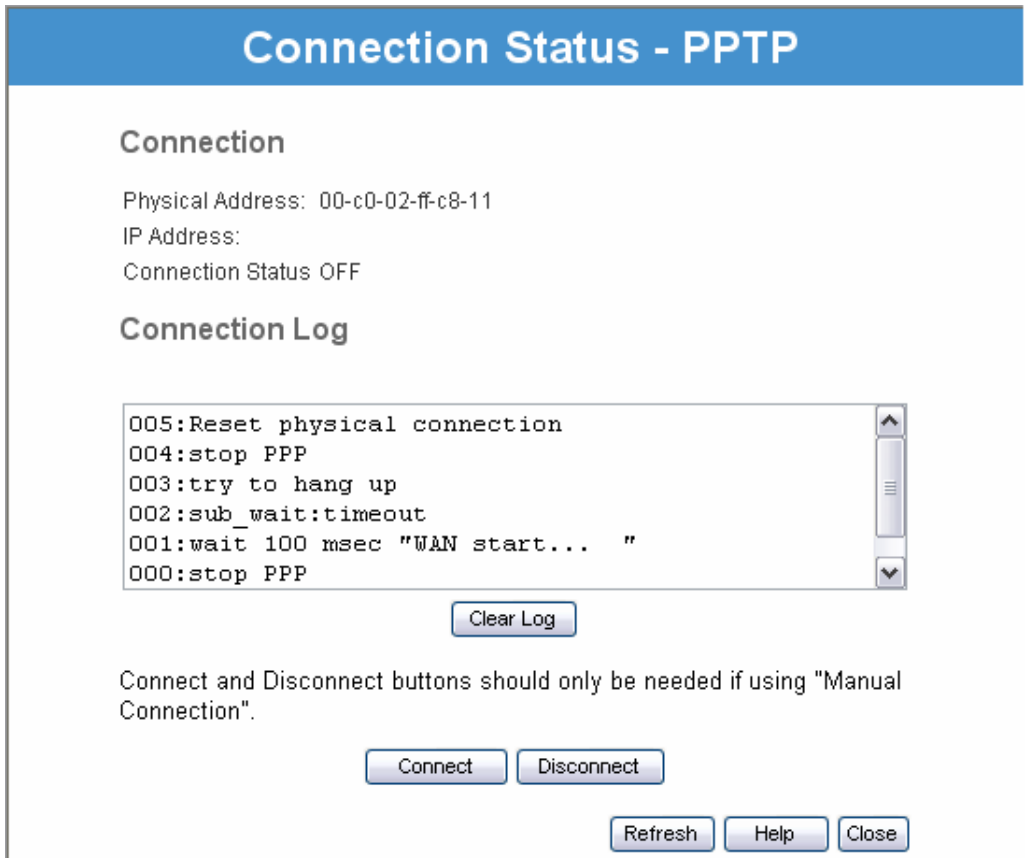

Figure 29: Telstra Big Pond Status Screen

Data - Big Pond Screen

Connection	
Physical Address	The hardware address of this device, as seen by remote devices. (This is different to the hardware address seen by devices on the local LAN.)
IP Address	The IP Address of this device, as seen by Internet users. This address is allocated by your ISP (Internet Service Provider).
Connection Status	<p>This indicates whether or not the connection is currently established.</p> <ul style="list-style-type: none"> • If the connection does not exist, the "Connect" button can be used to establish a connection. • If the connection currently exists, the "Disconnect" button can be used to break the connection. • Normally, it is not necessary to use the Connect and Disconnect buttons unless the setting "Connect automatically, as required" is disabled.

Connection Log	
Connection Log	<ul style="list-style-type: none"> The Connection Log shows status messages relating to the existing connection. The Clear Log button will restart the Log, while the Refresh button will update the messages shown on screen.
Buttons	
Connect	If not connected, establish a connection to Telstra Big Pond.
Disconnect	If connected to Telstra Big Pond, terminate the connection.
Clear Log	Delete all data currently in the Log. This will make it easier to read new messages.
Refresh	Update the data on screen.

Connection Details - SingTel RAS

If using the SingTel RAS access method, a screen like the following example will be displayed when the "Connection Details" button is clicked.

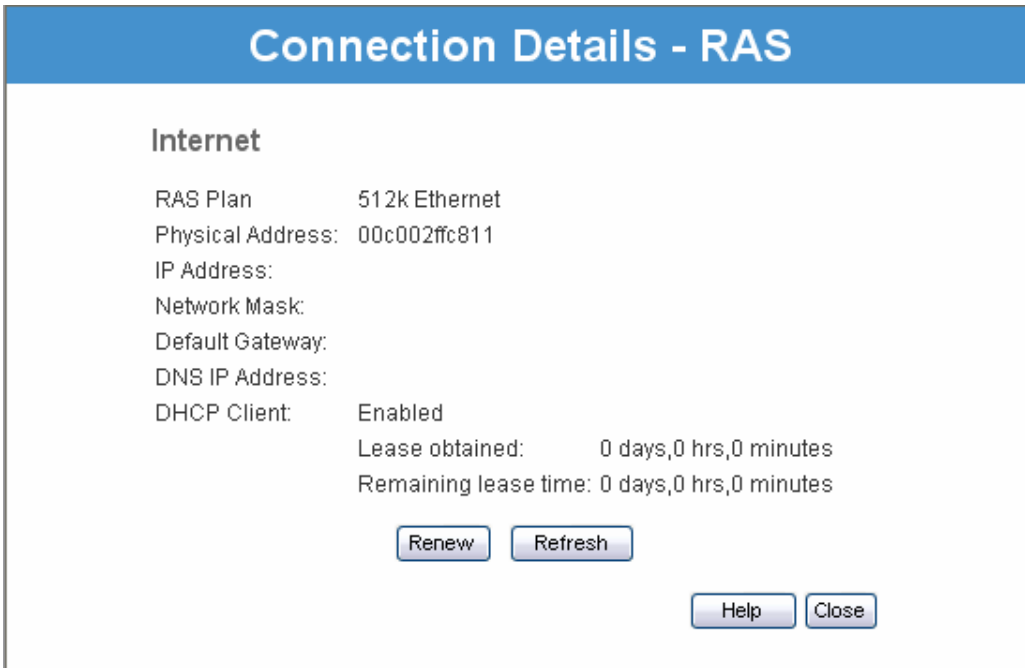

Figure 30: Connection Details - RAS

Data - RAS Screen

Internet	
RAS Plan	The RAS plan (connection speed) currently used.
Physical Address	The hardware address of this device, as seen by remote devices on the Internet. (This is different to the hardware address seen by devices on the local LAN.)

IP Address	The IP Address of this device, as seen by Internet users. This address is allocated by your ISP (Internet Service Provider).
Network Mask	The Network Mask associated with the IP Address above.
Default Gateway	The IP Address of the remote Gateway or Router associated with the IP Address above.
DNS IP Address	The IP Address of the Domain Name Server which is currently used.
DHCP Client	<ul style="list-style-type: none"> • This will show "Enabled" or "Disabled". • If "Enabled", the Internet IP Address from your ISP is allocated automatically upon connection. (Dynamic IP Address). In this case the "Lease obtained" and "Remaining lease time" fields provide additional information. Note that the lease is automatically renewed on expiry; use the "Renew" button if you wish to manually renew the lease immediately. • If "Disabled", the Internet IP Address from your ISP is Fixed or Static. In this case, the "Release/Renew" button is not operational.
Buttons	
Release/Renew	<p>This button is only useful if the IP address shown above is allocated automatically on connection. (Dynamic IP address). Otherwise, it has no effect.</p> <ul style="list-style-type: none"> • This button will say "Release" if the Wireless Router is currently using an IP Address allocated by the ISP's DHCP Server. Clicking the "Release" button will release the IP Address and break the connection. • If the button says "Renew", this indicates that the ISP's DHCP Server has not allocated an IP Address for the Wireless Router. Clicking the "Renew" button will re-establish the connection and obtain an IP Address from the ISP's DHCP Server.
Refresh	Update the data shown on screen.

Connection Details - Fixed/Dynamic IP Address

If your access method is "Direct" (no login), a screen like the following example will be displayed when the "Connection Details" button is clicked.

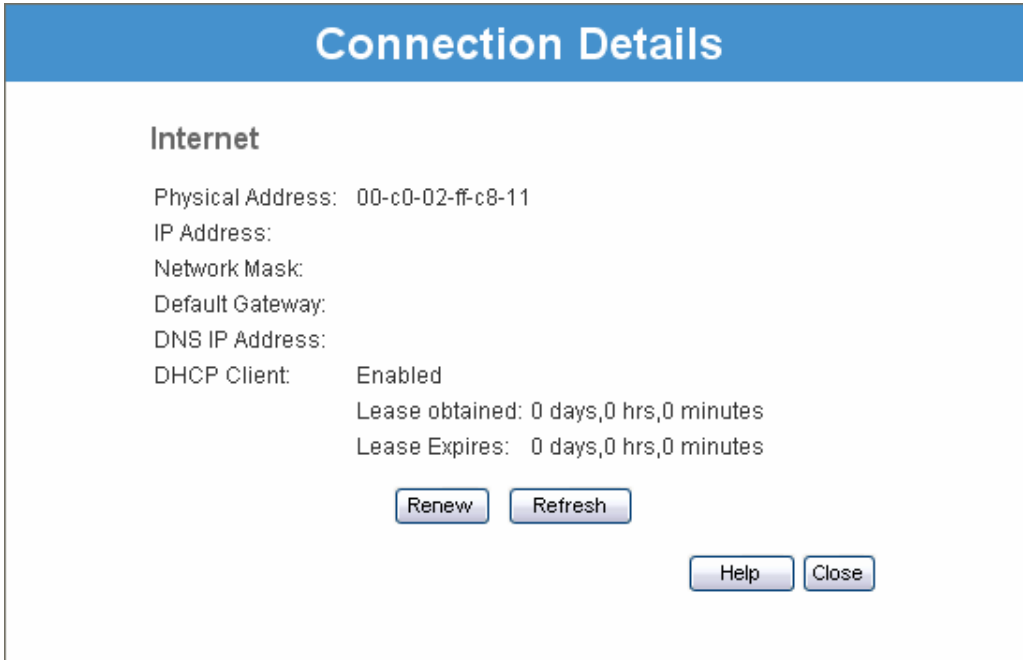

Figure 31: Connection Details - Fixed/Dynamic IP Address

Data - Fixed/Dynamic IP address Screen

Internet	
Physical Address	The hardware address of this device, as seen by remote devices on the Internet. (This is different to the hardware address seen by devices on the local LAN.)
IP Address	The IP Address of this device, as seen by Internet users. This address is allocated by your ISP (Internet Service Provider).
Network Mask	The Network Mask associated with the IP Address above.
Default Gateway	The IP Address of the remote Gateway or Router associated with the IP Address above.
DNS IP Address	The IP Address of the Domain Name Server which is currently used.
DHCP Client	<p>This will show "Enabled" or "Disabled".</p> <ul style="list-style-type: none"> • If "Enabled", the Internet IP Address from your ISP is allocated automatically upon connection. (Dynamic IP Address). In this case the "Lease obtained" and "Remaining lease time" fields provide additional information. Note that the lease is automatically renewed on expiry; use the "Renew" button if you wish to manually renew the lease immediately. • If "Disabled", the Internet IP Address from your ISP is Fixed or Static. In this case, the "Release/Renew" button is not operational.

Buttons	
Release/Renew	<ul style="list-style-type: none">• This button is only useful if the IP address shown above is allocated automatically on connection. (Dynamic IP address). Otherwise, it has no effect.• This button will say "Release" if the Wireless Router is currently using an IP Address allocated by the ISP's DHCP Server. Clicking the "Release" button will release the IP Address and break the connection.• If the button says "Renew", this indicates that the ISP's DHCP Server has not allocated an IP Address for the Wireless Router. Clicking the "Renew" button will re-establish the connection and obtain an IP Address from the ISP's DHCP Server.
Refresh	Update the data shown on screen.

Chapter 6

6

Advanced Features

This Chapter explains when and how to use the Wireless Router's "Advanced" Features.

Overview

The following advanced features are provided.

- Access Control
- Dynamic DNS
- Internet
 - Communication Applications
 - Special Applications
 - Multi-DMZ
- URL Filter
- Schedule
- User Groups
- Virtual Servers
- WAN Port

Access Control

This feature is accessed by the *Access Control* link on the Advanced menu.

Overview

The Access Control feature allows administrators to restrict the level of Internet Access available to PCs on your LAN. With the default settings, everyone has unrestricted Internet access.

To use this feature:

1. Set the desired restrictions on the "Default" group. All PCs are in the "Default" group unless explicitly moved to another group.
2. Set the desired restrictions on the other groups ("Group 1", "Group 2", "Group 3" and "Group 4") as needed.
3. Assign PC to the groups as required.



Restrictions are imposed by blocking "Services", or types of connections. All common Services are pre-defined. If required, you can also define your own Services.

Access Control Screen

To view this screen, select the *Access Control* link on the Advanced menu.

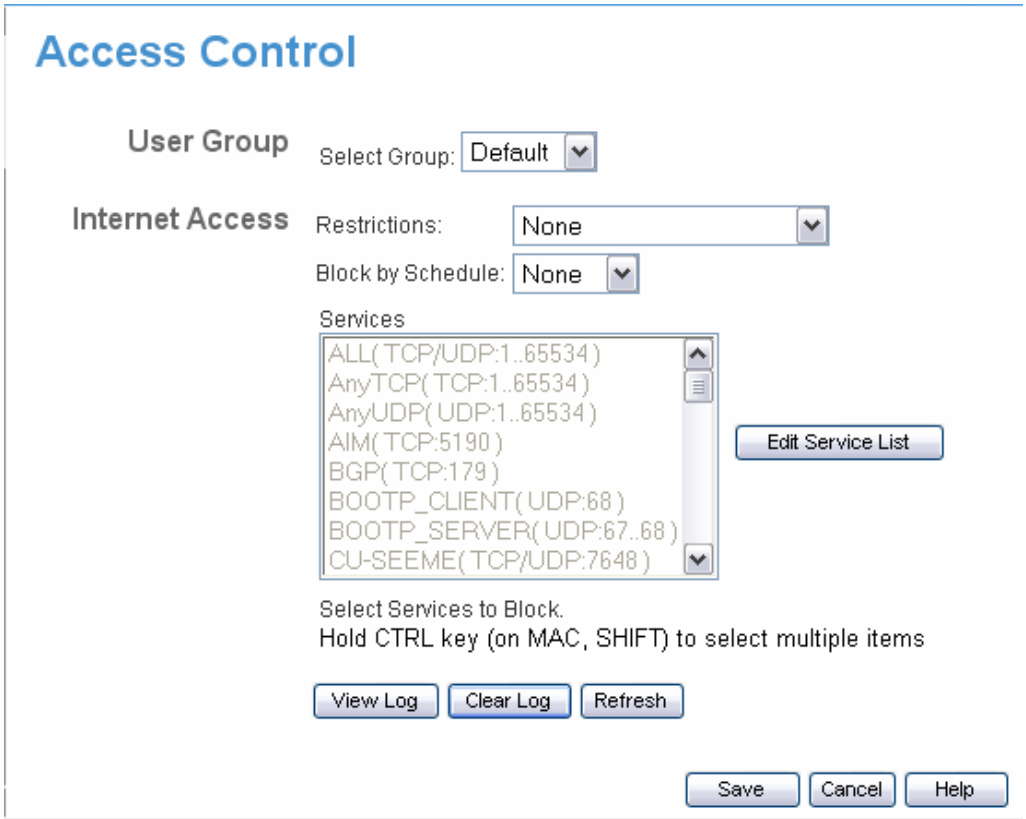

Figure 32: Access Control Screen

Data - Access Control Screen

User Group	
Select Group	Select the desired Group. The screen will update to display the settings for the selected Group. Groups are named "Default", "Group 1", "Group 2", "Group 3" and "Group 4", and cannot be re-named.
Internet Access	
Restrictions	<p>Select the desired options for the current group:</p> <ul style="list-style-type: none"> • None - Nothing is blocked. Use this to create the least restrictive group. • Block all Internet access - All traffic via the WAN port is blocked. Use this to create the most restrictive group. • Block selected Services - You can select which Services are to block. Use this to gain fine control over the Internet access for a group.

Block by Schedule	If Internet access is being blocked, you can choose to apply the blocking only during scheduled times. (If access is not blocked, no Scheduling is possible, and this setting has no effect.)
Services	This lists all defined Services. Select the Services you wish to block. To select multiple services, hold the CTRL key while selecting. (On the Macintosh, hold the SHIFT key rather than CTRL.)
Edit Service List Button	If you wish to define additional Services, or manage the Service list, click this button to open the "Services" screen.
Buttons	
Edit Service List	If you wish to define additional Services, or manage the Service list, click this button to open the "Services" screen.
View Log	Click this to open a sub-window where you can view the "Access Control" log. This log shows attempted Internet accesses which have been blocked by the Access Control feature.
Clear Log	Click this to clear and restart the "Access Control" log, making new entries easier to read.

Services Screen

This screen is displayed when the *Edit Service List* button on the *Access Control* screen is clicked.



Figure 33: Access Control - Services

Data - Services Screen

Available Services	
Available Services	This lists all the available services.
"Delete" button	Use this to delete the selected Service from the list.
Add New Service	
Name	Enter a descriptive name to identify this service.
Type	Select the correct type for this Service.
Start Port	If the "Type" (above) is TCP, UDP, or TCP/UDP, enter the port number for this Service. If a port range is required, enter the beginning of the range here, and the end of the range in the "Finish Port" field.
Finish Port	If the "Type" (above) is TCP, UDP, or TCP/UDP, this field can be used to enter the end of range of port numbers. This can be left blank if not required.
ICMP Type	If the "Type" (above) is ICMP, enter the ICMP type here. Otherwise, this field should be left blank.

Access Control Log

To check the operation of the Access Control feature, an *Access Control Log* is provided. Click the *View Log* button on the *Access Control* screen to view this log.

This log shows attempted Internet accesses which have been **blocked** by the *Access Control* function.

Data shown in this log is as follows:

Date/Time	Date and Time of the attempted access.
Name	If known, the name of the PC whose access was blocked.
Source IP address	The IP Address of the PC or device whose access request was blocked
MAC address	The hardware or physical address of the PC or device whose access request was blocked
Destination	The destination URL or IP address

Dynamic DNS (Domain Name Server)

This free service is very useful when combined with the *Virtual Server* feature. It allows Internet users to connect to your Virtual Servers using a URL, rather than an IP Address.

This also solves the problem of having a dynamic IP address. With a dynamic IP address, your IP address may change whenever you connect, which makes it difficult to connect to you.

The Service works as follows:

1. You must register for the service at one of the listed DDNS Service Providers.
2. After registration, follow the service provider's procedure to request a Domain Name and have it allocated to you.
3. Enter your DDNS data on the Wireless Router's DDNS screen.
4. The Wireless Router will then automatically ensure that your current IP Address is recorded at the DDNS server.
If the DDNS Service provides software to perform this "IP address update"; you should disable the "Update" function, or not use the software at all.
5. From the Internet, users will be able to connect to your Virtual Servers (or DMZ PC) using your Domain Name.

Dynamic DNS Screen

Select *Advanced* on the main menu, then *Dynamic DNS*, to see a screen like the following:

Dynamic DNS

DDNS Service You must Register for DDNS service at one of the listed Service suppliers.

DDNS Service:

DDNS Status:

DDNS Data

User Name:

Password/Key:

Domain Name: . .

Domain name allocated to you by the Service

Figure 34: DDNS Screen

Data - Dynamic DNS Screen

DDNS Data	
DDNS Service	Select the desired DDNS Service provider. To disable DDNS, select "None".
DDNS Status	<ul style="list-style-type: none"> • This message is returned by the DDNS Server. • Normally, this message should be something like "Update"

	<p>successful" (current IP address was updated on the DDNS server).</p> <ul style="list-style-type: none"> • If the message is "No host", this indicates the host name entered was not allocated to you. If you see this, or some other error message, you need to contact the DDNS Service and correct the problem.
Web Site Button	Click this button to open a new window and connect to the Web site for the selected DDNS service provider.
User Name	Enter your Username for the DDNS Service.
Password	Enter your current password for the DDNS Service.
Domain Name	<ul style="list-style-type: none"> • Enter the domain name allocated to you by the DDNS Service. • If you have more than one domain name, enter the name you wish to use. This device supports one name only.

Advanced Internet Screen

This screen allows configuration of all advanced features relating to Internet access.

- Communication Applications
- Special Applications
- DMZ
- Multi-DMZ

An example screen is shown below.

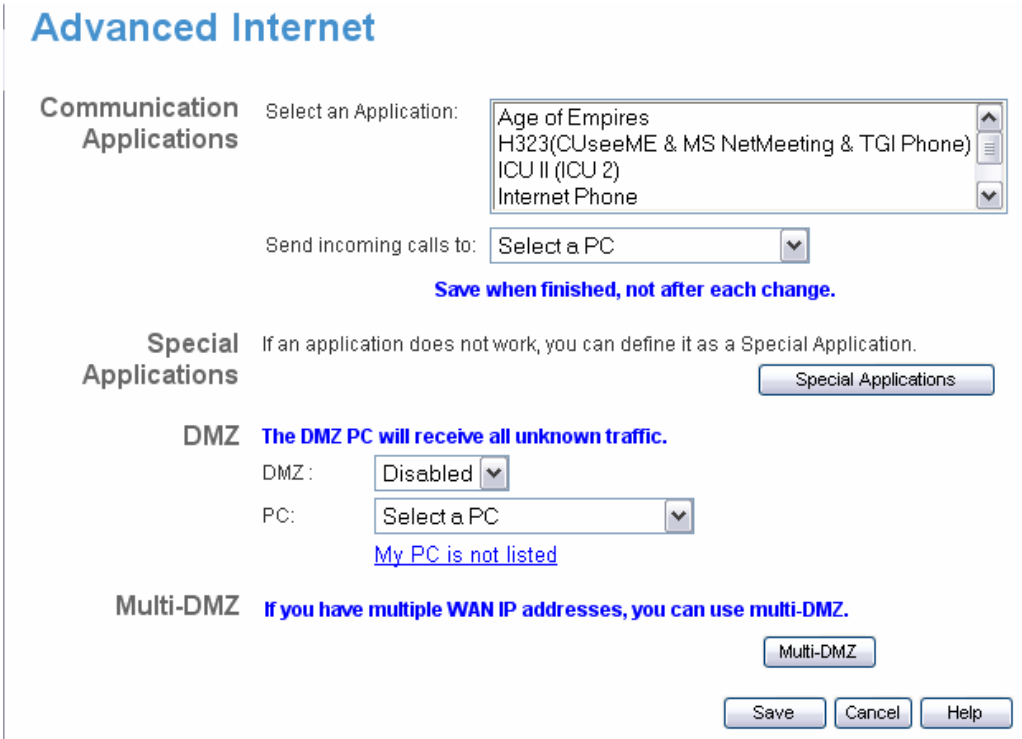

Figure 35: Internet Screen

Communication Applications

Most applications are supported transparently by the Wireless Router. But sometimes it is not clear which PC should receive an incoming connection. This problem could arise with the *Communication Applications* listed on this screen.

If this problem arises, you can use this screen to set which PC should receive an incoming connection, as described below.

Communication Applications	
Select an Application	This lists applications which may generate incoming connections, where the destination PC (on your local LAN) is unknown.

Send incoming calls to

This lists the PCs on your LAN.

- If necessary, you can add PCs manually, using the "PC Database" option on the advanced menu.
- For each application listed above, you can choose a destination PC.
- There is no need to "Save" after each change; you can set the destination PC for each application, then click "Save".

Special Applications

If you use Internet applications which use non-standard connections or port numbers, you may find that they do not function correctly because they are blocked by the Wireless Router's firewall. In this case, you can define the application as a "Special Application".

Special Applications Screen

This screen can be reached by clicking the *Special Applications* button on the *Internet* screen.

You can then define your Special Applications. You will need detailed information about the application; this is normally available from the supplier of the application.

Also, note that the terms "Incoming" and "Outgoing" on this screen refer to traffic from the client (PC) viewpoint

Special Applications

Special Applications can only be used by 1 user at any time.

		Incoming Ports			Outgoing Ports		
	Name	Type	Start	Finish	Type	Start	Finish
1.	<input type="checkbox"/> dialpad	udp	200	456	udp	200	456
2.	<input type="checkbox"/> paltalk	udp	10760	11016	udp	10760	11016
3.	<input type="checkbox"/> quicktime	udp	14875	22299	tcp	10754	10754
4.	<input type="checkbox"/>	udp			udp		
5.	<input type="checkbox"/>	udp			udp		
6.	<input type="checkbox"/>	udp			udp		
7.	<input type="checkbox"/>	udp			udp		
8.	<input type="checkbox"/>	udp			udp		
9.	<input type="checkbox"/>	udp			udp		
10.	<input type="checkbox"/>	udp			udp		
11.	<input type="checkbox"/>	udp			udp		
12.	<input type="checkbox"/>	udp			udp		

Figure 36: Special Applications Screen

Data - Special Applications Screen

Name	Enter a descriptive name to identify this Special Application.
Incoming Ports	<ul style="list-style-type: none"> • Type - Select the protocol (TCP or UDP) used when you receive data from the special application or service. (Note: Some applications use different protocols for outgoing and incoming data). • Start - Enter the beginning of the range of port numbers used by the application server, for data you receive. If the application uses a single port number, enter it in both the "Start" and "Finish" fields. • Finish - Enter the end of the range of port numbers used by the application server, for data you receive.
Outgoing Ports	<ul style="list-style-type: none"> • Type - Select the protocol (TCP or UDP) used when you send data to the remote system or service. • Start - Enter the beginning of the range of port numbers used by the application server, for data you send to it. If the application uses a single port number, enter it in both the "Start" and "Finish" fields. • Finish - Enter the end of the range of port numbers used by the application server, for data you send to it. If the application uses a single port number, enter it in both the "Start" and "Finish" fields.

Using a Special Application

- Configure the *Special Applications* screen as required.
- On your PC, use the application normally. Remember that only one (1) PC can use each Special application at any time. Also, when 1 PC is finished using a particular Special Application, there may need to be a "Time-out" before another PC can use the same Special Application. The "Time-out" period may be up to 3 minutes.



Note!

If an application still cannot function correctly, try using the "DMZ" feature.

DMZ

- The "DMZ" PC will receive all "Unknown" connections and data. This feature is normally used with applications which do not usually work when behind a Firewall.
- The DMZ PC is effectively outside the Firewall, making it more vulnerable to attacks. For this reason, you should only enable the DMZ feature when required.
- If Enabled, you must select the PC to be used as the "DMZ" PC.

Select the desired option

- **Disabled** - DMZ is disabled.
- **Enabled**- The selected PC is a standard PC on your LAN, but it will receive any "unknown" connections and data, as described above.

Multi-DMZ

This feature, if enabled, allows the DMZ computer or computers on your LAN to be exposed to all users on the Internet.

- This allows almost any application to be used on the "DMZ PC".
- The "DMZ PC" will receive all "Unknown" connections and data.
- If the DMZ feature is enabled, you must select the PC to be used as the "DMZ PC".

Multi-DMZ

Enable	WAN IP Address				PC
<input type="checkbox"/>	0	0	0	0	Select a PC
<input type="checkbox"/>	0	0	0	0	Select a PC
<input type="checkbox"/>	0	0	0	0	Select a PC
<input type="checkbox"/>	0	0	0	0	Select a PC
<input type="checkbox"/>	0	0	0	0	Select a PC
<input type="checkbox"/>	0	0	0	0	Select a PC

[My PC is not listed](#)

To use this feature:

- Enter an IP address allocated to you by your ISP into the **WAN IP address** field.
- Select the **PC** to be the DMZ PC for traffic sent to this IP address.
- **Enable** this DMZ.

If you have multiple Internet IP addresses, you can assign one DMZ PC for each Internet IP address.

If you only have 1 WAN IP address, only "DMZ 1" can be used, and only one (1) PC can be the DMZ PC. The current WAN IP address is displayed. If this address is assigned upon connection, and no connection currently exists, then this address will be blank or 0.0.0.0.



The "DMZ PC" is effectively outside the Firewall, making it more vulnerable to attacks. For this reason, you should only enable the DMZ feature when required.

URL Filter

The URL Filter allows you to block access to undesirable Web site

- To use this feature, you must define "filter strings". If the "filter string" appears in a requested URL, the request is blocked.
- Enabling the *URL Filter* also affects the *Internet Access Log*. If Enabled, the "Destination" field in the log will display the URL. Otherwise, it will display the IP Address.

URL Filter Screen

Click the "URL Filter" on the *Advanced* menu to access the *URL Filter* screen. An example screen is shown below.

URL Filter

Settings Enable URL Filter

Schedule: ▼

Apply Filter to: Default Group

Group 1 Group 2

Group 3 Group 4

Filter Strings **Requests for URLs containing any of these strings are blocked.**

Add Filter Filter String:

Filter Strings should be as specific as possible.

Figure 37: URL Filter Screen

Data - URL Filter Screen

Settings	
Enable	This lists any existing entries. If you have not entered any values, this list will be empty.
Schedule	If you always want filtering to be active, select "Always". Otherwise, select the schedule to use. You can define the schedule using the <i>Schedule</i> menu option, on the <i>Advanced</i> menu.
Apply Filter to	Select the groups you wish the filter to apply to. Group membership can be set on the "User Groups" screen, on the "Administration" menu.

Filter Strings	
Filter Strings	This lists any existing entries. If you have not entered any values, this list will be empty.
Delete	Use this to delete the selected entry or entries, as required. Multiple entries can be selected by holding down the CTRL key while selecting. (On the Macintosh, hold the SHIFT key while selecting.)
Delete All	Use this button to delete all entries, if required.
Add Filter	
Filter String	To add an entry to the list, enter it here, and click the "Add" button. An entry may be a Domain name (e.g. www.trash.com) or simply a string (e.g. ads/) Any URL which contains ANY entry ANYWHERE in the URL will be blocked.
Add Button	Use this to add the entry in the "Filter String" above to the list.
Buttons	
Delete/Delete All	Use these buttons to delete the selected entry or all entries, as required. Multiple entries can be selected by holding down the CTRL key while selecting.(On the Macintosh, hold the SHIFT key while selecting.)
Add	Use this to add the current Filter String to the site list.

User Groups

User Groups are used by the **Access Control** and the **URL Filter** features.

- Groups are pre-named "Default", "Group 1", "Group 2", "Group 3" and "Group 4", and cannot be renamed.
- All PCs are in the "Default" group, unless moved to another group.
- A PC can be a member of 1 group only.
- PCs must be in the "PC Database". If required, you can manually add PCs to the PC Database, using the *PC Database* option on the *Administration* menu.

User Groups

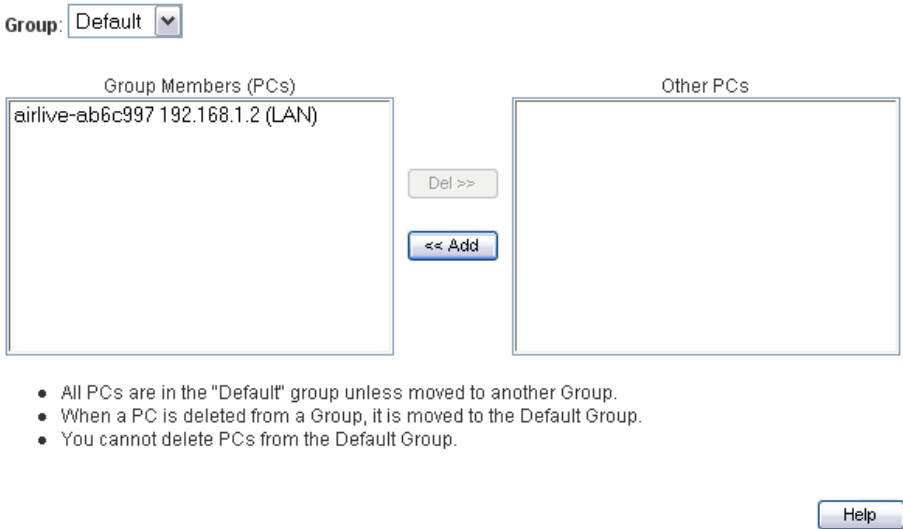

- All PCs are in the "Default" group unless moved to another Group.
- When a PC is deleted from a Group, it is moved to the Default Group.
- You cannot delete PCs from the Default Group.

Figure 39: User Groups Screen

Data – User Groups Screen

Group	Select the desired Group. The screen will update to display the PCs for the selected Group.
Group Members	This lists all PCs, which are currently members of the selected group.
Other PCs	This lists all other PCs – those, which are not currently members of the selected group.
Del >>	Use this button to remove members from the current Group. Select the members you wish to delete from this group, and click this button. (Members can not be deleted from the "Default" group.)
<< Add	Use this button to add members to the current Group. In the "Other PCs" list, select the members you wish to add to this group, and click this button. The PCs will be moved from their existing group to the current group.



Note!

PCs not assigned to any group will be in the "Default" group. PCs deleted from any other Group will be added to the "Default" group.

Virtual Servers

This feature, sometimes called *Port Forwarding*, allows you to make Servers on your LAN accessible to Internet users. Normally, Internet users would not be able to access a server on your LAN because:

- Your Server does not have a valid external IP Address.
- Attempts to connect to devices on your LAN are blocked by the firewall in this device.

The "Virtual Server" feature solves these problems and allows Internet users to connect to your servers, as illustrated below.

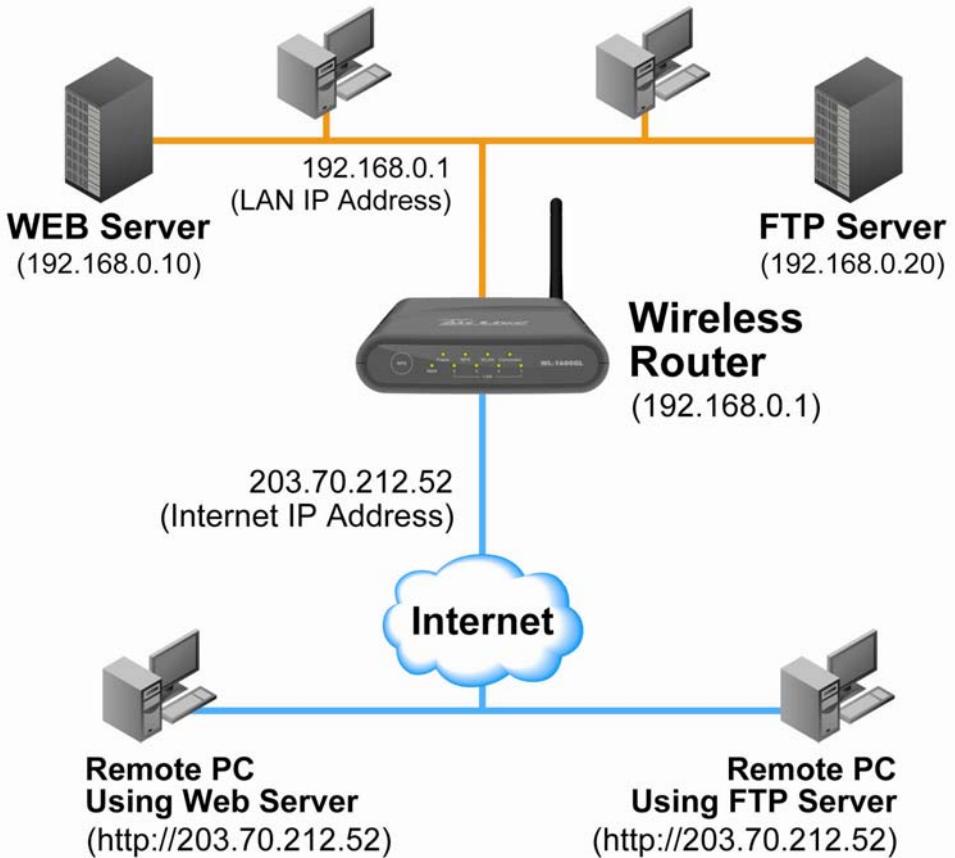

Figure 40: Virtual Servers

IP Address seen by Internet Users

Note that, in this illustration, both Internet users are connecting to the same IP Address, but using different protocols.

To Internet users, all virtual Servers on your LAN have the same IP Address. This IP Address is allocated by your ISP.

This address should be static, rather than dynamic, to make it easier for Internet users to connect to your Servers.

However, you can use the *DDNS (Dynamic DNS)* feature to allow users to connect to your Virtual Servers using a URL, instead of an IP Address.

Virtual Servers Screen

The *Virtual Servers* screen is reached by the *Virtual Servers* link on the *Advanced* screen. An example screen is shown below.

Virtual Servers

Servers

Web
FTP
E-Mail(POP3)
E-Mail(SMTP)
DNS

Defaults
Disable All
Delete

Properties

Enable Web

PC (Server): Select a PC [My PC is not listed](#)

Protocol: TCP

Internal (LAN) Ports: 80 ~ 80

External (WAN) Ports: 80 ~ 80

Clear Form

Update Selected Server Add as new Server

Help

Figure 41: Virtual Servers Screen

This screen lists a number of pre-defined Servers, and allows you to define your own Servers. Details of the selected Server are shown in the "Properties" area.

Data - Virtual Servers Screen

Servers	
Servers	This lists a number of pre-defined Servers, plus any Servers you have defined. Details of the selected Server are shown in the "Properties" area.
Properties	
Enable	Use this to Enable or Disable support for this Server, as required.
PC (Server)	Select the PC for this Server. The PC must be running the appropriate Server software.
Protocol	Select the protocol (TCP or UDP) used by the Server.
Internal (LAN) Ports	Enter the range of port numbers which the Server software is configured to use.

External (WAN) Ports	Traffic from the Internet using this range of port numbers will be sent to the Server. This is normally the same as the Internal Port Numbers. If it is different, this device will perform a "mapping" or "translation" function, allowing the server to use a different port range to the clients.
Buttons	
Delete	Delete the current Virtual Server entry. Note that the pre-defined Servers can not be deleted. Only Servers you have defined yourself can be deleted.
Defaults	This will delete any Servers you have defined, and set the pre-defined Servers to use their default port numbers.
Disable All	This will cause the "Enable" setting of all Virtual Servers to be set OFF.
Clear Form	Clear all data from the "Properties" area, ready for input of a new Virtual Server entry.
Update Selected Server	Update the current Virtual Server entry, using the data shown in the "Properties" area on screen.
Add as new Server	Add a new entry to the Virtual Server list, using the data shown in the "Properties" area on screen. The entry selected in the list is ignored, and has no effect.



For each entry, the PC must be running the appropriate Server software.

Defining your own Virtual Servers

If the type of Server you wish to use is not listed on the *Virtual Servers* screen, you can define and manage your own Servers:

Create a new Server:

1. Click "Clear Form"
2. Enter the required data, as described above.
3. Click "Add".
4. The new Server will now appear in the list.

Modify (Edit) a Server:

1. Select the desired Server from the list
2. Make any desired changes (for example, change the Enable/Disable setting).
3. Click "Update" to save changes to the selected Server.

Delete a Server:

1. Select the entry from the list.
2. Click "Delete".

Note: You can only delete Servers you have defined. Pre-defined Server cannot be deleted.



Note!

From the Internet, ALL Virtual Servers have the IP Address allocated by your ISP.

Connecting to the Virtual Servers

Once configured, anyone on the Internet can connect to your Virtual Servers. They must use the Internet IP Address (the IP Address allocated to you by your ISP).

e.g.

`http://203.70.212.52`

`ftp://203.70.212.52`

It is more convenient if you are using a Fixed IP Address from your ISP, rather than Dynamic. However, you can use the *Dynamic DNS* feature, described in the following section, to allow users to connect to your Virtual Servers using a URL, rather than an IP Address.

WAN Port Configuration

The *WAN Port* option is on the *Advanced* menu.

WAN Port

Port Settings MTU Size: (1 ~ 1500) bytes

Identification Hostname:
 Domain Name:
 MAC Address:

IP Address IP Address is assigned automatically (Dynamic IP address)
 Specified IP Address (Static IP Address)

IP address . . .

Network Mask . . .

Gateway . . .

PPPoE: Mask & Gateway not required.
PPPoE Unnumbered IP: Gateway not required.

DNS Automatically obtain from Server
 Use this DNS . . .

Login Login Method: ▾
 Login User Name:
 Login Password:
 RAS Plan: ▾ (SingTel RAS only)
 Server Address **(Not required for PPPoE, SingTel RAS)**
 Name:
 IP address: . . .
 Connection behavior: ▾
 Auto-disconnect idle time-out: min

TTL Value TTL Standard TTL Keep TTL +1 TTL =1 User Defined

Figure 42: WAN Port Screen

Data - WAN Port Screen

MTU Size	<ul style="list-style-type: none"> • MTU (Maximum Transmission Unit) value should only be changed if advised to do so by Technical Support. • Enter a value between 1 and 1500. • This device will still auto-negotiate with the remote server, to set the MTU size. The smaller of the 2 values (auto-negotiated, or entered here) will be used. • For direct connections (not PPPoE or PPTP), the MTU used is always 1500.
Identification	
Hostname	Normally, there is no need to change the default name, but if your ISP requests that you use a particular Hostname, enter it here.
Domain Name	If your ISP provided a domain name, enter it here. Otherwise, this may be left blank.
MAC Address	<p>Also called <i>Network Adapter Address</i> or <i>Physical Address</i>. This is a low-level identifier, as seen from the WAN port.</p> <p>Normally there is no need to change this, but some ISPs require a particular value, often that of the PC initially used for Internet access.</p> <p>You can use the <i>Copy from PC</i> button to copy your PC's address into this field, the <i>Default</i> button to insert the default value, or enter a value directly.</p>
IP Address	
IP Address is assigned automatically	<p>Also called Dynamic IP Address. This is the default, and the most common.</p> <p>Leave this selected if your ISP allocates an IP Address to the Wireless Router upon connection.</p>
Specified IP Address	<p>Also called Static IP Address. Select this if your ISP has allocated you a fixed IP Address. If this option is selected, the following data must be entered.</p> <ul style="list-style-type: none"> • IP Address The IP Address allocated by the ISP. • Network Mask This is also supplied by your ISP. It must be compatible with the IP Address above. • Gateway IP Address The address of the router or gateway, as supplied by your ISP. <p>Note:</p> <ul style="list-style-type: none"> • For "PPPoE" connections, the Network Mask and Gateway IP address are NOT required. • For "PPPoE Unnumbered IP" connections, the Gateway IP address is NOT required.
DNS	
Automatically obtain from Server	<p>The DNS (Domain Name Server) address will be obtained automatically from your ISP's server.</p> <p>Note that if using a fixed IP address, with no login (login is set to "None"), then no Server is used, so this option cannot be used.</p>

Use this DNS	If this option is selected, you must enter the IP address of the DNS (Domain Name Server) you wish to use.
---------------------	--

Note: If the DNS is unavailable, the "Backup DNS", entered on the "Options" screen, will be used.

Login

Login Method	<p>If your ISP does not use a login method (username, password) for Internet access, leave this at the default value None (Direct connection). Otherwise, check the documentation from your ISP, select the login method used, and enter the required data.</p> <ul style="list-style-type: none"> • PPPoE - this is the most common login method, widely used with DSL modems. Normally, your ISP will have provided some software to connect and login. This software is no longer required, and should not be used. • PPPoE (Unnumbered IP) - this can only be used if your ISP supports this system, and has allocated you multiple IP addresses. If selected, you must also select "Specified IP Address" above and enter one of the IP addresses allocated to you by your ISP. • PPTP - this is mainly used in Europe. You need to know the PPTP Server address as well as your name and password. • Big Pond Cable - for Australia only. • SingTel RAS - for Singapore only. • L2TP - this is not widely used. You need to know the PPTP Server address as well as your name and password.
Login User Name	The User Name (or account name) provided by your ISP.
Login Password	Enter the password for the login name above.
RAS Plan	For SingTel customers only, select the RAS plan you are on.
Server Address	<p>If using PPTP, L2TP, or Big Pond Cable, the Server address is required.</p> <ul style="list-style-type: none"> • For PPTP and L2TP, you can select and enter either the name or IP address of your ISP's server. • For Big Pond Cable, you must select "IP" and enter the IP address of the Big Pond Server.
Connection Behavior	<p>Select the desired option:</p> <ul style="list-style-type: none"> • Automatic Connect/Disconnect An Internet connection is automatically made when required, and disconnected when idle for the time period specified by the "Auto-disconnect Idle Time-out". • Manual Connect/Disconnect You must manually establish and terminate the connection. • Keep alive (maintain connection) The connection will never be disconnected by this device. If disconnected by your ISP, the connection will be re-established immediately. (However, this does not ensure that your Internet IP address will remain unchanged.)

Auto-disconnect Idle Time-out	This field has no effect unless using the Automatic Connect/Disconnect setting. If using this setting, enter the desired idle time-out period (in minutes). After the connection to your ISP has been idle for this time period, the connection will be terminated.
Buttons	
Default	Inserts the default MAC address into the MAC address field. You must click "Save" to actually change the address used.
Copy from PC	Inserts the MAC address from your PC into the MAC address field. You must click "Save" to actually change the address used.
Save	Save your changes to the Wireless Router.
Cancel	Reverse any changes made since the last "Save".

Chapter 7



Advanced Administration

This Chapter explains the settings available via the "Administration" section of the menu.

Overview

Normally, it is not necessary to use these screens, or change any settings. These screens and settings are provided to deal with non-standard situations, or to provide additional options for advanced users.

The available settings and features are:

Config File	Backup or restore the configuration file for the Wireless Router. This file contains all the configuration data.
Logs	View or clear all logs, set E-Mailing of log files.
Network Diagnostics	Ping, DNS Lookup.
Options	Various options, such as backup DNS, UPnP, and enable TFTP firmware upgrade option.
PC Database	This is the list of PCs shown when you select the "DMZ PC" or a "Virtual Server". This database is maintained automatically, but you can add and delete entries for PCs which use a Fixed (Static) IP Address.
Remote Administration	Allow settings to be changed from the Internet..
Routing	Only required if your LAN has other Routers or Gateways.
Security	Firewall and other security-related settings. Normally, the default settings do not need to be changed.
Upgrade Firmware	Upgrade the Firmware (software) installed in your Wireless Router.

Config File

This feature allows you to download the current settings from the Wireless Router, and save them to a file on your PC.

You can restore a previously-downloaded configuration file to the Wireless Router, by uploading it to the Wireless Router.

This screen also allows you to set the Wireless Router back to its factory default configuration. Any existing settings will be deleted.

An example *Config File* screen is shown below.

Config File

Backup Config Download a copy of the current settings. Download

Restore Config Restore previously saved settings from a file. Browse... Restore

Default Config Restore factory default settings. Restore Defaults Cancel Help

Figure 43: Config Screen

Data - Config File Screen

Backup Config	Use this to download a copy of the current configuration, and store the file on your PC. Click <i>Download</i> to start the download.
Restore Config	This allows you to restore a previously-saved configuration file back to the Wireless Router. Click <i>Browse</i> to select the configuration file, then click <i>Restore</i> to upload the configuration file. WARNING! Uploading a configuration file will destroy (overwrite) ALL of the existing settings.
Default Config	Clicking the <i>Restore Defaults</i> button will reset the Wireless Router to its factory default settings. WARNING! This will delete ALL of the existing settings.

Logs

The Logs record various types of activity on the Wireless Router. This data is useful for troubleshooting, but enabling all logs will generate a large amount of data and adversely affect performance.

Since only a limited amount of log data can be stored in the Wireless Router, log data can also be E-mailed to your PC.

Logs

Enable Logs

Outgoing (Internet) connections

Access Control

DoS (Denial or Service) attacks

Timezone:

E-mail Alerts Send E-mail alert immediately when attacked

E-mail Logs

Send Logs: Never
 When log is full
 Every Sunday at AM

Include:

Connection Log
E-mail Subject:

Access Control Log
E-mail Subject:

DoS attack Log
E-mail Subject:

E-mail Address

E-mail address:

SMTP Server:

Address:

IP address: . . .

Port No. (Default: 25)

Server requires login to send mail
Login Name:
Password:

Figure 44: Logs Screen

Data - Logs Screen

Enable Logs	
Outgoing	If selected, Outgoing Internet connections are logged. Normally, the (Internet) "Destination" will be shown as an IP address. But if the "URL Filter" is enabled, the "Destination" will be shown as a URL.
Access Control	If enabled, the log will include attempted outgoing connections which have been blocked by the "Access Control" feature.

DoS Attacks	If enabled, this log will show details of DoS (Denial of Service) attacks which have been blocked by the built-in Firewall.
Timezone	Select the correct Timezone for your location. This is required for the date/time shown on the logs to be correct.
View Log button	Use this to view each log, as required.
Clear Log button	Use this to restart the required log. This makes it easier to read the latest entries.
E-Mail	
Send E-mail alert..	If enabled, an E-mail will be sent immediately if a DoS (Denial of Service) attack is detected. If enabled, the E-mail address information must be provided.
Send	Select the desired option for sending the log by E-mail. <ul style="list-style-type: none"> • Never - If it is selected, the log will not be sent. • When log is full - The time is not fixed. The log will be sent when the log is full, which will depend on the volume of traffic. • Every day, Every Monday ... - The log is sent on the interval specified. <ul style="list-style-type: none"> • If "Every day" is selected, the log is sent at the time specified. • If the day is specified, the log is sent once per week, on the specified day. • Select the time of day you wish the E-mail to be sent. • If the log is full before the time specified to send it, it will be sent regardless.
Include	Enabled the logs you wish to send. If no checkboxes are enabled, no logs will be sent. Enter the text string to be shown in the "Subject" field for the E-mail.
E-Mail Address	
E-mail Address	Enter the E-mail address the Log is to be sent to. The E-mail will also show this address as the Sender's address.
SMTP Server	Enter the address (domain name) or IP address of the SMTP (Simple Mail Transport Protocol) Server you use for outgoing E-mail.
Port No.	Enter the port number used to connect to the SMTP Server. The default value is 25.
Server requires login to send mail	If your SMTP Server requires you to login in order to send mail, check the "Server requires login to send mail" checkbox, and enter your login name and password on the SMTP Server.

Network Diagnostics

This screen allows you to perform a "Ping" or a "DNS lookup". These activities can be useful in solving network problems.

An example *Network Diagnostics* screen is shown below.

Network Diagnostics

Ping Ping this IP Address: . . .

Ping Results

DNS Lookup Domain name/URL:

DNS Lookup Results

Figure 45: Network Diagnostics Screen

Data - Network Diagnostics Screen

Ping	
Ping IP Address	Enter the IP address you wish to ping. The IP address can be on your LAN, or on the Internet. Note that if the address is on the Internet, and no connection currently exists, you could get a "Timeout" error. In that case, wait a few seconds and try again.
Ping Button	After entering the IP address, click this button to start the "Ping" procedure. The results will be displayed in the <i>Ping Results</i> pane.

DNS Lookup	
Domain name/URL	Enter the Domain name or URL for which you want a DNS (Domain Name Server) lookup. Note that if the address is on the Internet, and no connection currently exists, you could get a "Timeout" error. In that case, wait a few seconds and try again.
Lookup Button	After entering the Domain name/URL, click this button to start the "DNS Lookup" procedure. The results will be displayed in the <i>DNS Lookup Results</i> pane.

Options

This screen allows advanced users to enter or change a number of settings. For normal operation, there is no need to use this screen or change any settings.

An example *Options* screen is shown below.

Options

Backup DNS

Backup DNS (1) IP Address: . . .

Backup DNS (2) IP Address: . . .

These DNS (Domain Name Servers) are used only if the primary DNS is unavailable.

UPnP

- Enable UPnP Services
- Allow configuration changes through UPnP
- Allow Internet access to be disabled

Figure 46: Options Screen

Data - Options Screen

Backup DNS	
DNS IP Address	Enter the IP Address of the DNS (Domain Name Servers) here. These DNS will be used only if the primary DNS is unavailable.
UPnP	
Enable UPnP Services	<ul style="list-style-type: none"> • UPnP (Universal Plug and Play) allows automatic discovery and configuration of equipment attached to your LAN. UPnP is by supported by Windows ME, XP, or later. • If Enabled, this device will be visible via UPnP. • If Disabled, this device will not be visible via UPnP.
Allow Configuration...	<ul style="list-style-type: none"> • If checked, then UPnP users can change the configuration. • If Disabled, UPnP users can only view the configuration. But currently, this restriction only applies to users running Windows XP, who access the <i>Properties</i> via UPnP. (e.g. Right - click the Wireless Router in <i>My Network Places</i>, and select <i>Properties</i>)
Allow Internet access to be disabled	<ul style="list-style-type: none"> • If checked, then UPnP users can disable Internet access via this device. • If Disabled, UPnP users can NOT disable Internet access via this device. But currently, this restriction only applies to users running Windows XP, who access the <i>Properties</i> via UPnP. (e.g. Right - click the Wireless Router in <i>My Network Places</i>, and select <i>Properties</i>)

PC Database

The PC Database is used whenever you need to select a PC (e.g. for the "DMZ" PC). It eliminates the need to enter IP addresses. Also, you do not need to use fixed IP addresses on your LAN.

PC Database Screen

An example *PC Database* screen is shown below.

PC Database

[DHCP Clients](#) are automatically added and updated.
If not listed, try restarting the PC.

PCs using a [Fixed IP address](#) can be added and deleted below.

Known PCs

airlive-ab6c997 192.168.1.2 (LAN) (DHCP)	Name: <input type="text"/> IP Address: <input type="text"/> . <input type="text"/> . <input type="text"/> . <input type="text"/>
--	---

Figure 47: PC Database

- PCs which are "DHCP Clients" are automatically added to the database, and updated as required.
- By default, non-Server versions of Windows act as "DHCP Clients"; this setting is called "Obtain an IP Address automatically".
- The Wireless Router uses the "Hardware Address" to identify each PC, not the name or IP address. The "Hardware Address" can only change if you change the PC's network card or adapter.
- This system means you do NOT need to use Fixed (static) IP addresses on your LAN. However, you can add PCs using Fixed (static) IP Addresses to the PC database if required.

Data - PC Database Screen

Known PCs	This lists all current entries (PCs or network devices).
Name	If adding a new PC to the list, enter its name here. It is best if this matches the PC's "hostname".
IP Address	If adding a new PC to the list, enter the IP Address of the PC here. The PC will be sent a "ping" to determine its hardware address. If the PC is not available (not connected, or not powered On) you will not be able to add it.
Buttons	
Add	This will add the new PC to the list. The PC will be sent a "ping" to determine its hardware address. If the PC is not available (not connected, or not powered On) you will not be able to add it.
Delete	Delete the selected PC from the list. This should be done in 2 situations: <ul style="list-style-type: none"> • The PC has been removed from your LAN. • The entry is incorrect.
Refresh	Update the data on screen.
Generate Report	Display a read-only list showing full details of all entries in the PC database.
Advanced	View the Advanced version of the PC database screen - <i>Advanced PC Database</i> . See below for details.

Advanced PC Database

This screen is displayed if the "Advanced" button on the *PC Database* is clicked. It provides more control than the standard *PC Database* screen.

Advanced PC Database

Any PC may be added, edited or deleted. If adding a PC which is not connected and On, you must provide the MAC (hardware) address

Known PCs

airlive-ab6c997 192.168.1.2 (LAN) 0013d42f26a3(DHCP)

PC Properties

Name:

IP Address: Automatic (DHCP Client)
 DHCP Client - reserved IP address: . . .
 Fixed IP address (set on PC): . . .

MAC Address: Automatic discovery (PC must be available on LAN)
 MAC address is

Figure 48: Advanced PC Database

Data - Advanced PC Database Screen

Known PCs	This lists all current entries (PCs or network devices).
Edit	Use this to change the data for the selected PC in the list. The data for the selected PC will then be shown in the "Properties" area, where it may be edited. (Click "Update" to save any changes.)
Delete	Use this to Delete the selected PC from the list. This should be done in 2 situations: <ul style="list-style-type: none"> • The PC has been removed from your LAN. • The entry is incorrect.
PC Properties	
Name	If adding a new PC to the list, enter its name here. It is best if this matches the PC's "hostname".

IP Address	<p>Select the appropriate option:</p> <ul style="list-style-type: none"> • Automatic - The PC is set to be a DHCP client (Windows: "Obtain an IP address automatically"). The Wireless Router will allocate an IP address to this PC when requested to do so. The IP address could change, but normally won't. • DCHP Client - Reserved IP Address - Select this if the PC is set to be a DCHP client, and you wish to guarantee that the Wireless Router will always allocate the same IP Address to this PC. Enter the required IP address. Only the last field is required; the other fields must match the Wireless Router's IP address. • Fixed IP Address - Select this if the PC is using a Fixed (Static) IP address. Enter the IP address allocated to the PC. (The PC must be configured to use this IP address.)
MAC Address	<p>Select the appropriate option</p> <ul style="list-style-type: none"> • Automatic discovery - Select this to have the Wireless Router contact the PC and find its MAC address. This is only possible if the PC is connected to the LAN and powered On. • MAC address is - Enter the MAC address on the PC. The MAC address is also called the "Hardware Address", "Physical Address", or "Network Adapter Address". The Wireless Router uses this to provide a unique identifier for each PC. Because of this, the MAC address can NOT be left blank.
Buttons	
Add as New Entry	<p>Add a new PC to the list, using the data in the "Properties" box. If "Automatic discovery" (for MAC address) is selected, the PC will be sent a "ping" to determine its hardware address. This will fail unless the PC is connected to the LAN, and powered on.</p>
Update Selected PC	<p>Update (modify) the selected PC, using the data in the "Properties" box.</p>
Clear Form	<p>Clear the "Properties" box, ready for entering data for a new PC.</p>
Refresh	<p>Update the data on screen.</p>
Generate Report	<p>Display a read-only list showing full details of all entries in the PC database.</p>
Standard Screen	<p>Click this to view the standard <i>PC Database</i> screen.</p>

Remote Admin

If enabled, this feature allows you to manage the Wireless Router via the Internet.

Remote Administration

Remote Administration

If enabled, this device can be administered via the Internet, using your Web Browser. See help for details of the "Port Number".

Enable Remote Management

Port Number:

Current IP Address to connect to this device:

Figure 49: Remote Administration Screen

Data - Remote Administration Screen

Remote Administration	
Enable Remote Management	<p>Check to allow administration/management via the Internet. (To connect, see below).</p> <p>If Disabled, this device will ignore Administration connection attempts from the Internet.</p>
Port Number	<p>Enter a port number between 1024 and 65535. The default for HTTP (Web) connections is port 80, but using port 80 will prevent the use of a Web "Virtual Server" on your LAN. So using a different port number is recommended. The default value is 8080.</p> <p>The port number must be specified in your Browser when you connect. To specify the port number :</p> <ol style="list-style-type: none"> From a remote location, start your Browser. In the "Address" or "Location" field, enter the Internet IP address of this device (NOT the LAN IP address), followed by the port number, as follows: <code>http://ip_address:port_number</code> Where: ip_address is the Internet IP address of this device. port_number is the port number assigned on this screen. You should then be prompted for the password for this device. (You must assign a password!)
Current IP Address..	<p>To manage this device via the Internet, you need to know the IP Address of this device, as seen from the Internet. This IP Address is allocated by your ISP, and is shown here. But if using a Dynamic IP Address, this value can change each time you connect to your ISP. There are 2 solutions to this problem:</p> <ul style="list-style-type: none"> Have your ISP allocate you a Fixed IP address. Use the DDNS feature (Advanced menu) so you can connect using a Domain Name, rather than an IP address.

To connect from a remote PC via the Internet

1. Ensure your Internet connection is established, and start your Web Browser.
2. In the "Address" bar, enter "HTTP://" followed by the Internet IP Address of the Wireless Router. If the port number is not 80, the port number is also required. (After the IP Address, enter ":" followed by the port number.)

e.g.

`HTTP://123.123.123.123:8080`

This example assumes the WAN IP Address is 123.123.123.123, and the port number is 8080.

Routing

Overview

- If you don't have other Routers or Gateways on your LAN, you can ignore the "Routing" page completely.
- If the Wireless Router is only acting as a Gateway for the local LAN segment, ignore the "Routing" page even if your LAN has other Routers.
- If your LAN has a standard Router (e.g. Cisco) on your LAN, and the Wireless Router is to act as a Gateway for all LAN segments, enable RIP (Routing Information Protocol) and ignore the Static Routing table.
- If your LAN has other Gateways and Routers, and you wish to control which LAN segments use each Gateway, do NOT enable RIP (Routing Information Protocol). Configure the Static Routing table instead. (You also need to configure the other Routers.)
- If using Windows 2000 Data center Server as a software Router, enable RIP on the Wireless Router, and ensure the following Windows 2000 settings are correct:
 - Open *Routing and Remote Access*
 - In the console tree, select *Routing and Remote Access*, *[server name]*, *IP Routing*, *RIP*
 - In the "Details" pane, right-click the interface you want to configure for RIP version 2, and then click "Properties".
 - On the "General" tab, set *Outgoing packet protocol* to "RIP version 2 broadcast", and *Incoming packet protocol* to "RIP version 1 and 2".

Routing Screen

The routing table is accessed by the *Routing* link on the *Administration* menu.

Using this Screen

Generally, you will use either RIP (Routing Information Protocol) OR the Static Routing Table, as explained above, although it is possible to use both methods simultaneously.

Static Routing Table

- If RIP is not used, an entry in the routing table is required for each LAN segment on your Network, other than the segment to which this device is attached.
- The other Routers must also be configured. See *Configuring Other Routers on your LAN* later in this chapter for further details and an example.

Routing

RIP Enable RIP (Routing Information Protocol) V1

Static Routing

Static Routing Table Entries

<div style="border: 1px dashed gray; width: 100%; height: 100%;"></div>

Properties

Destination Network:	<input type="text"/>	.	<input type="text"/>	.	<input type="text"/>	.	<input type="text"/>
Network Mask:	<input type="text"/>	.	<input type="text"/>	.	<input type="text"/>	.	<input type="text"/>
Gateway IP Address:	<input type="text"/>	.	<input type="text"/>	.	<input type="text"/>	.	<input type="text"/>
Metric:	<input type="text"/>						
<input type="button" value="Clear Form"/>							

Figure 50: Routing Screen

Data - Routing Screen

RIP	
Enable RIP VI	Check this to enable the RIP (Routing Information Protocol) feature of the Wireless Router. The Wireless Router supports RIP 1 only.
Static Routing	
Static Routing Table Entries	This list shows all entries in the Routing Table. <ul style="list-style-type: none"> The "Properties" area shows details of the selected item in the list. Change any the properties as required, then click the "Update" button to save the changes to the selected entry.

Properties	<ul style="list-style-type: none"> • Destination Network - The network address of the remote LAN segment. For standard class "C" LANs, the network address is the first 3 fields of the Destination IP Address. The 4th (last) field can be left at 0. • Network Mask - The Network Mask for the remote LAN segment. For class "C" networks, the default mask is 255.255.255.0 • Gateway IP Address - The IP Address of the Gateway or Router which the Wireless Router must use to communicate with the destination above. (NOT the router attached to the remote segment.) • Metric - The number of "hops" (routers) to pass through to reach the remote LAN segment. The shortest path will be used. The default value is 2.
-------------------	--

Buttons	
Save	Save the RIP setting. This has no effect on the Static Routing Table.
Add	Add a new entry to the Static Routing table, using the data shown in the "Properties" area on screen. The entry selected in the list is ignored, and has no effect.
Update	Update the current Static Routing Table entry, using the data shown in the "Properties" area on screen.
Delete	Delete the current Static Routing Table entry.
Clear Form	Clear all data from the "Properties" area, ready for input of a new entry for the Static Routing table.
Generate Report	Generate a read-only list of all entries in the Static Routing table.

Configuring Other Routers on your LAN

It is essential that all IP packets for devices not on the local LAN be passed to the Wireless Router, so that they can be forwarded to the external LAN, WAN, or Internet. To achieve this, the local LAN must be configured to use the Wireless Router as the *Default Route* or *Default Gateway*.

Local Router

The local router is the Router installed on the same LAN segment as the Wireless Router. This router requires that the *Default Route* is the Wireless Router itself. Typically, routers have a special entry for the *Default Route*. It should be configured as follows.

Destination IP Address	Normally 0.0.0.0, but check your router documentation.
Network Mask	Normally 0.0.0.0, but check your router documentation.
Gateway IP Address	The IP Address of the Wireless Router.
Metric	1

Other Routers on the Local LAN

Other routers on the local LAN must use the Wireless Router's *Local Router* as the *Default Route*. The entries will be the same as the Wireless Router's local router, with the exception of the *Gateway IP Address*.

- For a router with a direct connection to the Wireless Router's local Router, the *Gateway IP Address* is the address of the Wireless Router's local router.
- For routers which must forward packets to another router before reaching the Wireless Router's local router, the *Gateway IP Address* is the address of the intermediate router.

Static Routing - Example

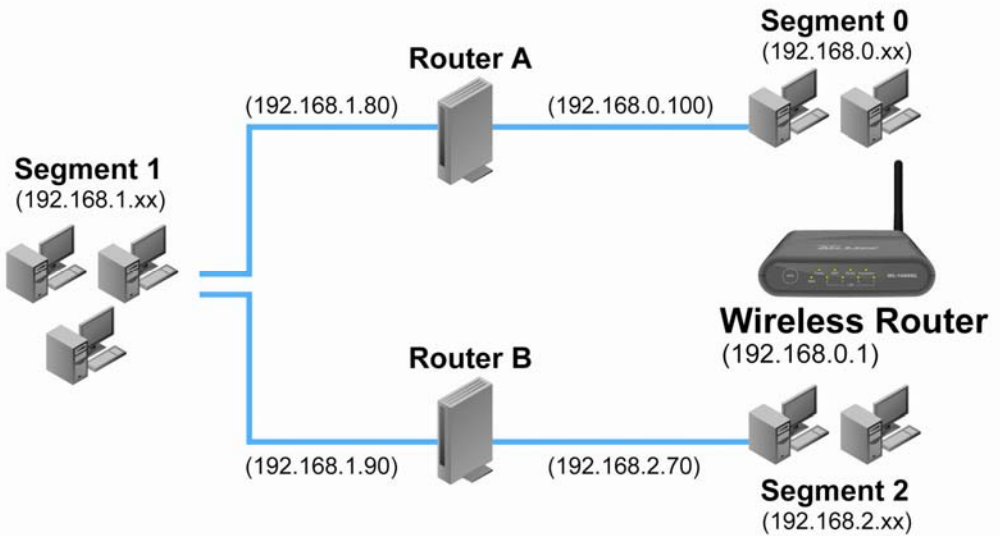

Figure 51: Routing Example

For the Wireless Router's Routing Table

For the LAN shown above, with 2 routers and 3 LAN segments, the Wireless Router requires 2 entries as follows.

Entry 1 (Segment 1)	
Destination IP Address	192.168.1.0
Network Mask	255.255.255.0 (Standard Class C)
Gateway IP Address	192.168.1.254 (Wireless Router's local Router)
Metric	2
Entry 2 (Segment 2)	
Destination IP Address	192.168.2.0
Network Mask	255.255.255.0 (Standard Class C)
Gateway IP Address	192.168.1.25400
Metric	3

For Router A's Default Route

Destination IP Address	0.0.0.0
------------------------	---------

Network Mask	0.0.0.0
Gateway IP Address	192.168.1.254 (Wireless Router's IP Address)

For Router B's Default Route

Destination IP Address	0.0.0.0
Network Mask	0.0.0.0
Gateway IP Address	192.168.1.80 (Wireless Router's local router)

Security

This screen allows you to set Firewall and other security-related options.

Security Options

DoS Firewall Enable DoS (Denial of Service) Firewall (Recommended) Firewall Settings

Options

- Respond to ICMP (Ping) on WAN interface
- Allow VPN Passthrough (IPsec, PPTP, L2TP)
- Drop fragmented IP packets
- Block TCP Flood
- Block UDP Flood
- Block non-standard packets

Save
Cancel
Help

Figure 52: Security Screen

Data - Security Screen

DoS Firewall	
Enable DoS Firewall	If enabled, DoS (Denial of Service) attacks will be detected and blocked. The default is enabled. It is strongly recommended that this setting be left enabled. <p>Note:</p> <ul style="list-style-type: none"> A DoS attack does not attempt to steal data or damage your PCs, but overloads your Internet connection so you can not use it - the service is unavailable. This device uses "Stateful Inspection" technology. This system can detect situations where individual TCP/IP packets are valid, but collectively they become a DoS attack.
Firewall Settings Button	If you wish to adjust the settings used by the DoS firewall, click this button to open a sub-window.
Options	
Respond to ICMP	The ICMP protocol is used by the "ping" and "tracert" programs, and by network monitoring and diagnostic programs. <ul style="list-style-type: none"> If checked, the Wireless Router will respond to ICMP packets received from the Internet. If not checked, ICMP packets from the Internet will be ignored. Disabling this option provides a slight increase in security.

Allow VPN Pass through	<p>The IPSec, PPTP, and L2TP protocols are used to establish a secure connection, and are widely used by VPN (Virtual Private Networking) programs.</p> <ul style="list-style-type: none"> • If checked, these VPN connections are allowed. • If not checked, these VPN connections are blocked. <p>Note: IPSec sessions must NOT use AH (Authentication Header). Packets using AH cannot be routed correctly.</p>
Drop fragmented IP packets	<p>If enabled, fragmented IP packets are discarded, forcing re-transmission of these packets. In some situations, this could prevent successful communication, so this setting is normally disabled.</p>
Block TCP Flood	<p>A TCP flood is excessively large number of TCP connection requests. This is usually a DoS (Denial of Service) attack. This setting should be normally be enabled.</p>
Block UDP Flood	<p>A UDP flood is excessively large number of UDP packets. This is often a DoS (Denial of Service) attack, but some streaming applications also use UDP, and blocking UPD packets may prevent them from working correctly.</p>
Block non-standard packets	<p>Abnormal packets are often used by hackers and in DoS attacks, but may also be generated by other network devices. (PCs will normally not generate non-standard packets.) This setting is disabled by default, but on most networks it can safely be enabled, and doing so will provide greater protection.</p>

Upgrade Firmware

The firmware (software) in the Wireless Router can be upgraded using your Web Browser. You must first download the upgrade file, then select *Upgrade* on the *Administration* menu. You will see a screen like the following.

Upgrade Firmware

Options The upgrade firmware file needs to be downloaded and stored on your PC.

Wireless Router Password:

Upgrade File:

Figure 53: Upgrade Firmware Screen

To perform the Firmware Upgrade:

1. Click the "Browse" button and navigate to the location of the upgrade file.
2. Select the upgrade file. Its name will appear in the *Upgrade File* field.
3. Click the "Start Upgrade" button to commence the firmware upgrade.



The Wireless Router is unavailable during the upgrade process, and must restart when the upgrade is completed. Any connections to or through the Wireless Router will be lost.

Appendix A

Troubleshooting



This Appendix covers the most likely problems and their solutions.

Overview

This chapter covers some common problems that may be encountered while using the Wireless Router and some possible solutions to them. If you follow the suggested steps and the Wireless Router still does not function properly, contact your dealer for further advice.

General Problems

Problem 1: **Can't connect to the Wireless Router to configure it.**

Solution 1: Check the following:

- The Wireless Router is properly installed, LAN connections are OK, and it is powered ON.
- Ensure that your PC and the Wireless Router are on the same network segment. (If you don't have a router, this must be the case.)
- If your PC is set to "Obtain an IP Address automatically" (DHCP client), restart it.
- If your PC uses a Fixed (Static) IP address, ensure that it is using an IP Address within the range 192.168.1.2 to 192.168.1.254 and thus compatible with the Wireless Router's default IP Address of 192.168.1.254. Also, the Network Mask should be set to 255.255.255.0 to match the Wireless Router.

In Windows, you can check these settings by using *Control Panel-Network* to check the *Properties* for the TCP/IP protocol.

Internet Access

Problem 1: **When I enter a URL or IP address I get a time out error.**

Solution 1: A number of things could be causing this. Try the following troubleshooting steps.

- Check if other PCs work. If they do, ensure that your PCs IP settings are correct. If using a Fixed (Static) IP Address, check the Network Mask, Default gateway and DNS as well as the IP Address.
- If the PCs are configured correctly, but still not working, check the Wireless Router. Ensure that it is connected and ON. Connect to it and check its settings. (If you can't connect to it, check the LAN and power connections.)
- If the Wireless Router is configured correctly, check your Internet connection (DSL/Cable modem etc) to see that it is working correctly.

Problem 2: **Some applications do not run properly when using the Wireless Router.**

Solution 2: The Wireless Router processes the data passing through it, so it is not transparent.

Use the *Special Applications* feature to allow the use of Internet applications which do not function correctly.

If this does solve the problem you can use the *DMZ* function. This should work with almost every application, but:

- It is a security risk, since the firewall is disabled.
- Only one (1) PC can use this feature.

Wireless Access

Problem 1: My PC can't locate the Wireless Access Point.

Solution 1: Check the following.

- Your PC is set to *Infrastructure Mode*. (Access Points are always in *Infrastructure Mode*)
- The SSID on your PC and the Wireless Access Point are the same. Remember that the SSID is case-sensitive. So, for example "Workgroup" does NOT match "workgroup".
- Both your PC and the Wireless Router must have the same setting for WEP. The default setting for the Wireless Router is disabled, so your wireless station should also have WEP disabled.
- If WEP is enabled on the Wireless Router, your PC must have WEP enabled, and the key must match.
- If the Wireless Router's *Wireless* screen is set to *Allow LAN access to selected Wireless Stations only*, then each of your Wireless stations must have been selected, or access will be blocked.
- To see if radio interference is causing a problem, see if connection is possible when close to the Wireless Router. Remember that the connection range can be as little as 100 feet in poor environments.

Problem 2: Wireless connection speed is very slow.

Solution 2: The wireless system will connect at the highest possible speed, depending on the distance and the environment. To obtain the highest possible connection speed, you can experiment with the following:

- Wireless Router location.
Try adjusting the location and orientation of the Wireless Router.
- Wireless Channel
If interference is the problem, changing to another channel may show a marked improvement.
- Radio Interference
Other devices may be causing interference. You can experiment by switching other devices Off, and see if this helps. Any "noisy" devices should be shielded or relocated.
- RF Shielding
Your environment may tend to block transmission between the wireless stations. This will mean high access speed is only possible when close to the Wireless Router.

About Wireless LANs

This Appendix provides some background information about using Wireless LANs (WLANs).

Modes

Wireless LANs can work in either of two (2) modes:

- Ad-hoc
- Infrastructure

Ad-hoc Mode

Ad-hoc mode does not require an Access Point or a wired (Ethernet) LAN. Wireless Stations (e.g. notebook PCs with wireless cards) communicate directly with each other.

Infrastructure Mode

In Infrastructure Mode, one or more Access Points are used to connect Wireless Stations (e.g. Notebook PCs with wireless cards) to a wired (Ethernet) LAN. The Wireless Stations can then access all LAN resources.



Access Points can only function in "Infrastructure" mode, and can communicate only with Wireless Stations which are set to "Infrastructure" mode.

Note!

BSS/ESS

BSS

A group of Wireless Stations and a single Access Point, all using the same ID (SSID), form a Basic Service Set (BSS).

Using the same SSID is essential. Devices with different SSIDs are unable to communicate with each other.

ESS

A group of Wireless Stations, and multiple Access Points, all using the same ID (ESSID), form an Extended Service Set (ESS).

Different Access Points within an ESS can use different Channels. In fact, to reduce interference, it is recommended that adjacent Access Points **SHOULD** use different channels.

As Wireless Stations are physically moved through the area covered by an ESS, they will automatically change to the Access Point which has the least interference or best performance. This capability is called **Roaming**. (Access Points do not have or require Roaming capabilities.)

Channels

The Wireless Channel sets the radio frequency used for communication.

- Access Points use a fixed Channel. You can select the Channel used. This allows you to choose a Channel which provides the least interference and best performance. In the USA and Canada, 11 channels are available. If using multiple Access Points, it is better if adjacent Access Points use different Channels to reduce interference.
- In "Infrastructure" mode, Wireless Stations normally scan all Channels, looking for an Access Point. If more than one Access Point can be used, the one with the strongest signal is used. (This can only happen within an ESS.)
- If using "Ad-hoc" mode (no Access Point), all Wireless stations should be set to use the same Channel. However, most Wireless stations will still scan all Channels to see if there is an existing "Ad-hoc" group they can join.

WEP

WEP (Wired Equivalent Privacy) is a standard for encrypting data before it is transmitted.

This is desirable because it is impossible to prevent snoopers from receiving any data which is transmitted by your Wireless Stations. But if the data is encrypted, then it is meaningless unless the receiver can decrypt it.

If WEP is used, the Wireless Stations and the Access Point must have the same settings for each of the following:

WEP	Off, 64 Bit, 128 Bit
Key	For 64 Bit encryption, the Key value must match. For 128 Bit encryption, the Key value must match
WEP Authentication	Open System or Shared Key.

WPA-PSK

WPA-PSK is another standard for encrypting data before it is transmitted. This is a later standard than WEP (Wired Equivalent Privacy), and provides greater security for your data. Data is encrypted using a 256Bit key which is automatically generated and changed often.

If all your Wireless stations support WPA-PSK, you should use this instead of WEP.

If WPA-PSK is used, the Wireless Stations and the Access Point must have the same settings for each of the following:

WPA PSK (Pre-shared Key)	Enter the same value on every station and the AP. The PSK must be from 8 to 63 characters in length. The 256Bit key used for the actual encryption is derived from this key.
Encryption	The same encryption method must be used. The most common encryption method is TKIP. Another widely-supported method is AES.

WPA2-PSK

This is a later version of WPA (WPA-PSK). The major change is the use of AES (Advanced Encryption System) for protecting data. AES is very secure, considered to be unbreakable. The PSK (Pre-shared Key) must be entered on each Wireless station.

If WPA2-PSK is used, the Wireless Stations and the Access Point must have the same settings for each of the following:

WPA2 PSK (Pre-shared Key)	Enter the same value on every station and the AP. The PSK must be from 8 to 63 characters in length. The 256Bit key used for the actual encryption is derived from this key.
Encryption	The same encryption method must be used. The most common encryption method is TKIP. Another widely-supported method is AES.

Wireless LAN Configuration

To allow Wireless Stations to use the Access Point, the Wireless Stations and the Access Point must use the same settings, as follows:

- Mode** On client Wireless Stations, the mode must be set to "Infrastructure". (The Access Point is always in "Infrastructure" mode.)
- Most Wireless stations will set the correct mode automatically.
- SSID (ESSID)** Wireless Stations should use the same SSID (ESSID) as the Access Point they wish to connect to. Alternatively, the SSID can be set to "any" or null (blank) to allow connection to any Access Point.
- Security** The Wireless Stations and the Access Point must use the same settings for Wireless security. (Off, WEP, WPA-PSK, WPA2-PSK, WPA-PSK+WPA2-PSK).
- WEP:** If WEP is used, the Key size (64Bit, 128Bit), Key value, and Authentication settings must be the same on the Wireless Stations and the Access Point.
- WPA-PSK:** If WPA is used, all Wireless Stations must be set to use WPA-PSK, and have the same Pre-shared Key and encryption system.
- WPA2-PSK:** If WPA2 is used, all Wireless Stations must be set to use WPA2-PSK, and have the same Pre-shared Key and encryption system.
- WPA-PSK +WPA2-PSK:** If WPA-PSK +WPA2-PSK is used, all Wireless Stations must be set to use WPA-PSK +WPA2-PSK, and have the same Pre-shared Key and encryption system.
- For **Ad-hoc networks** (no Access Point), all Wireless stations must use the same security settings.

Appendix C

Specifications



Multi-Function Wireless Router

Model	AirLive WL1600GL Wireless Router
Dimensions	103mm(W) * 150mm(D) * 37mm(H)
Operating Temperature	0° C to 40° C
Storage Temperature	-20° C to 70° C
Network Protocol:	TCP/IP
Network Interface:	5 Ethernet: 4 * 10/100BaseT (RJ45) LAN connection 1 * 10/100BaseT (RJ45) for WAN
LEDs	8
Power Adapter	12V External

Wireless Interface

Standards	IEEE802.11g WLAN, JEIDA 4.2, roaming support
Frequency	2.4 to 2.4835GHz (Industrial Scientific Medical Band)
Channels	Maximum 14 Channels, depending on regulatory authorities
Modulation	DSSS BPSK/QPSK/CCK, OFDM/CCK
Data Rate	Up to 54 Mbps
Coverage Area	Indoors : 15m @54Mbps, 120m @6Mbps or lower Outdoors : 40m @54Mbps, 300m @6Mbps or lower
WEP	64Bit, 128Bit
Output Power	13dBm (typical)
Receiver Sensitivity	-80dBm Min.

Regulatory Approvals

CE Standards

This product complies with the 99/5/EEC directives, including the following safety and EMC standards:

- EN300328-2
- EN301489-1/-17
- EN60950

CE Marking Warning

This is a Class B product. In a domestic environment this product may cause radio interference in which case the user may be required to take adequate measures.